

# Free pattern and instructions for small coin purse

with ... gusseted coin space  
four card space (two anti-drop flaps)  
a key and note pocket  
pen holder

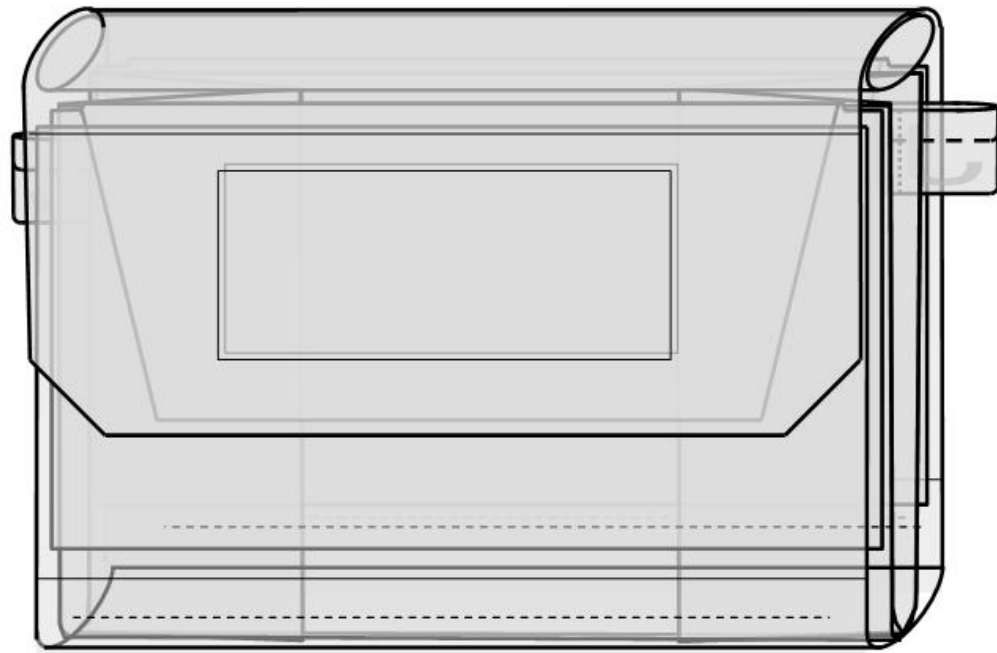

small outer shape

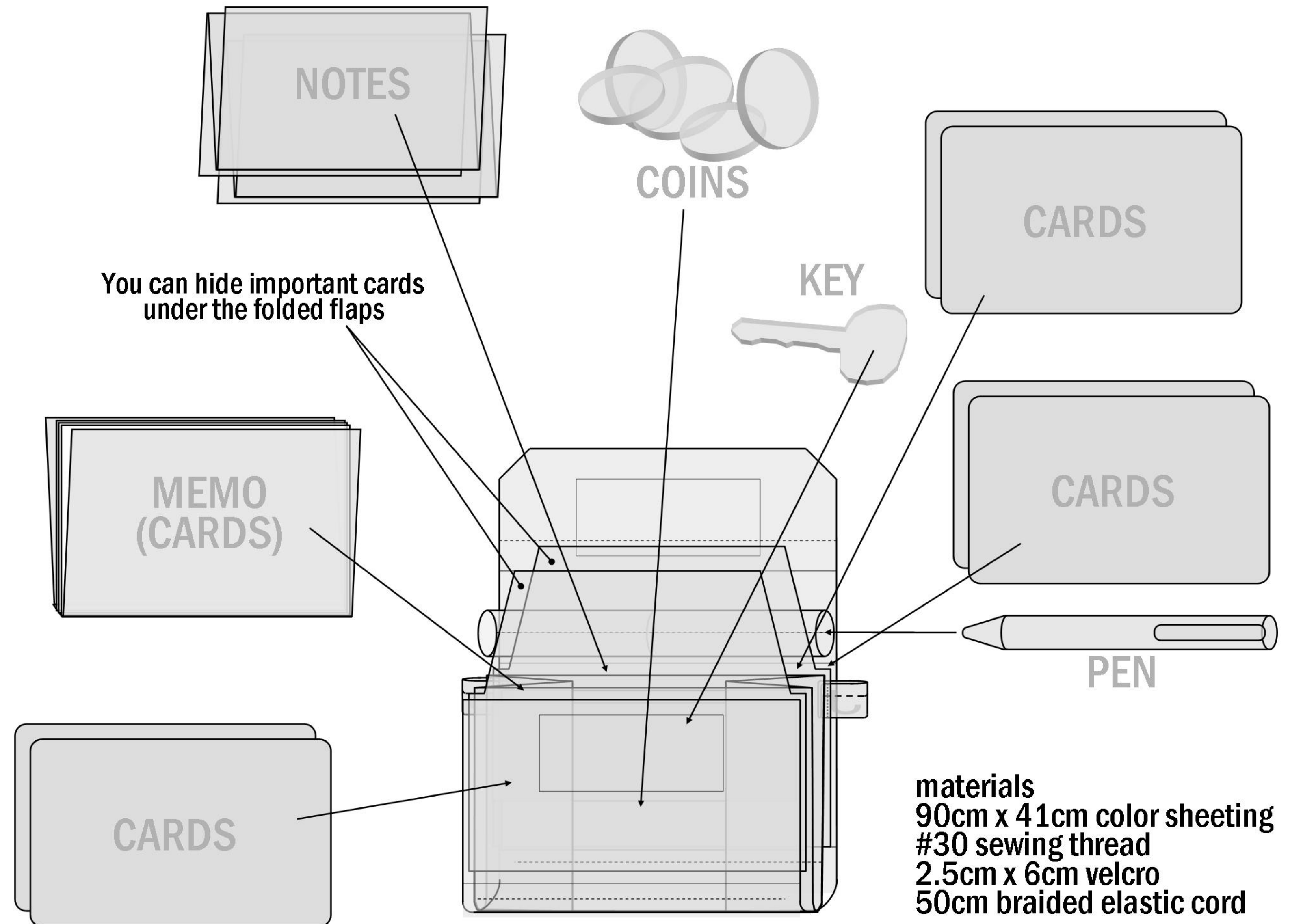

materials  
90cm x 41cm color sheeting  
#30 sewing thread  
2.5cm x 6cm velcro  
50cm braided elastic cord

# PATTERN-1

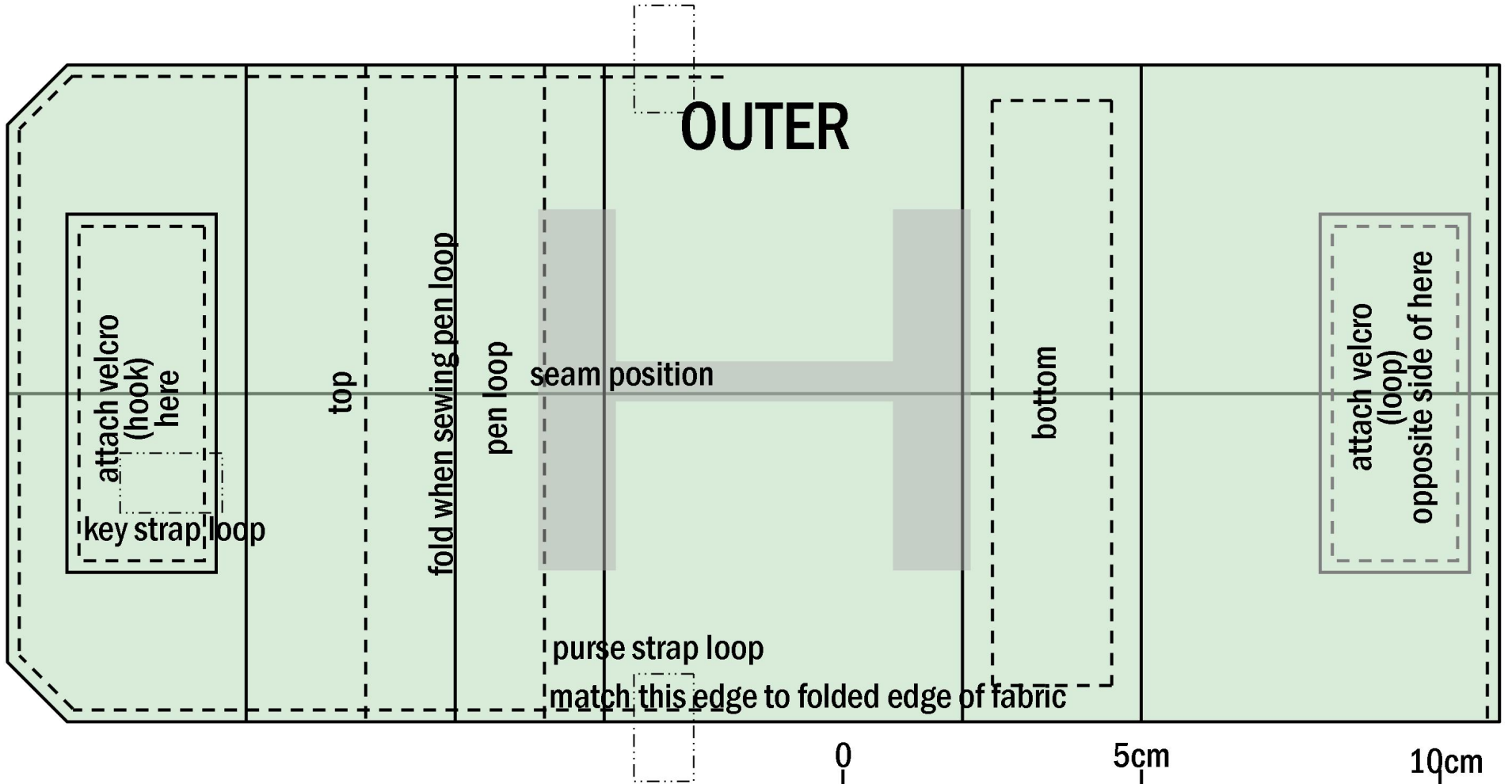

**OUTER**

attach velcro  
(hook)  
here

key strap loop

top

fold when sewing pen loop

pen loop

seam position

bottom

attach velcro  
(loop)  
opposite side of here

purse strap loop

match this edge to folded edge of fabric

0 5cm 10cm

applying a ruler, check size of your print out

## PATTERN-2

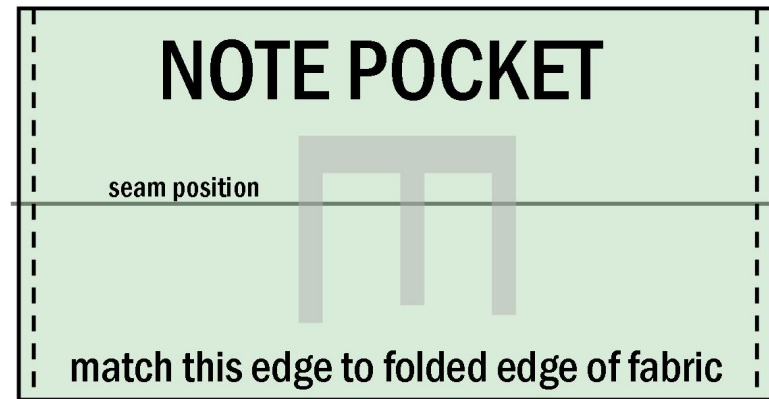
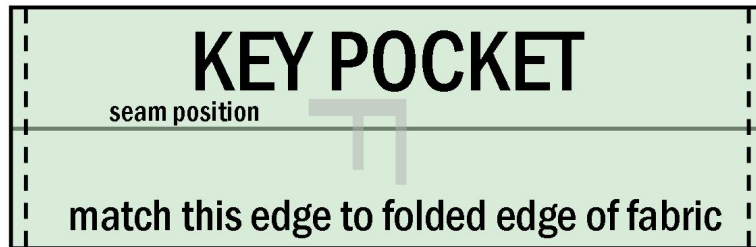

0 5cm 10cm

applying a ruler, check size of your print out

# PATTERN-3

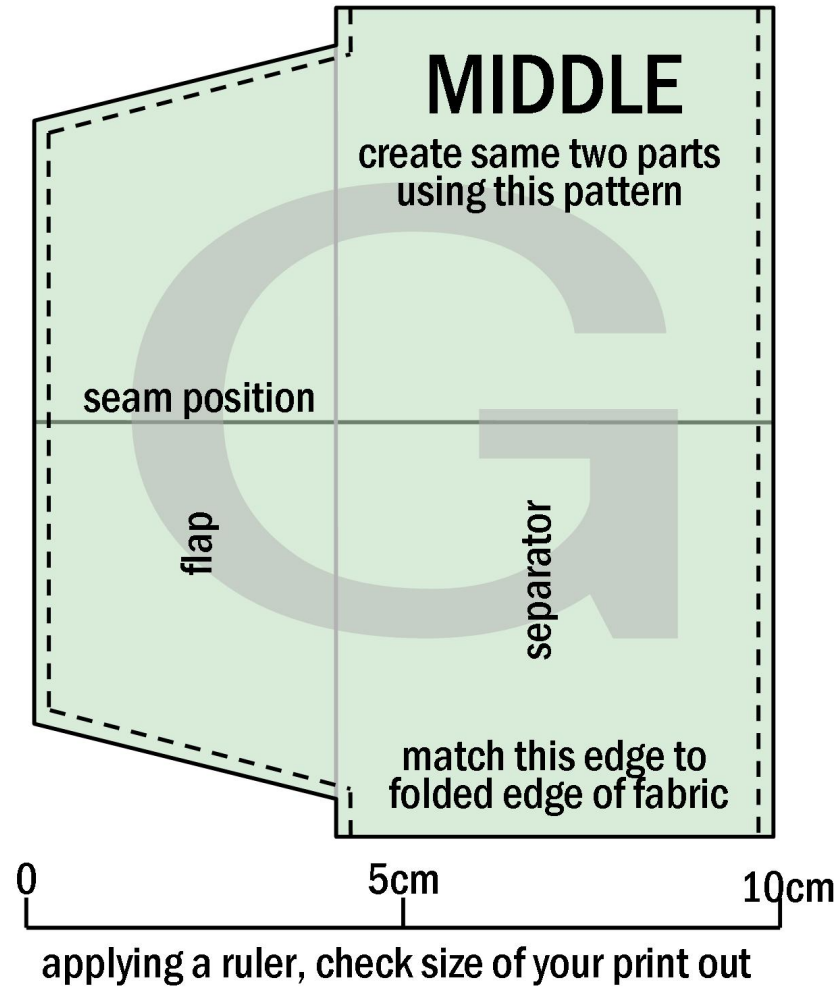

# PATTERN-4

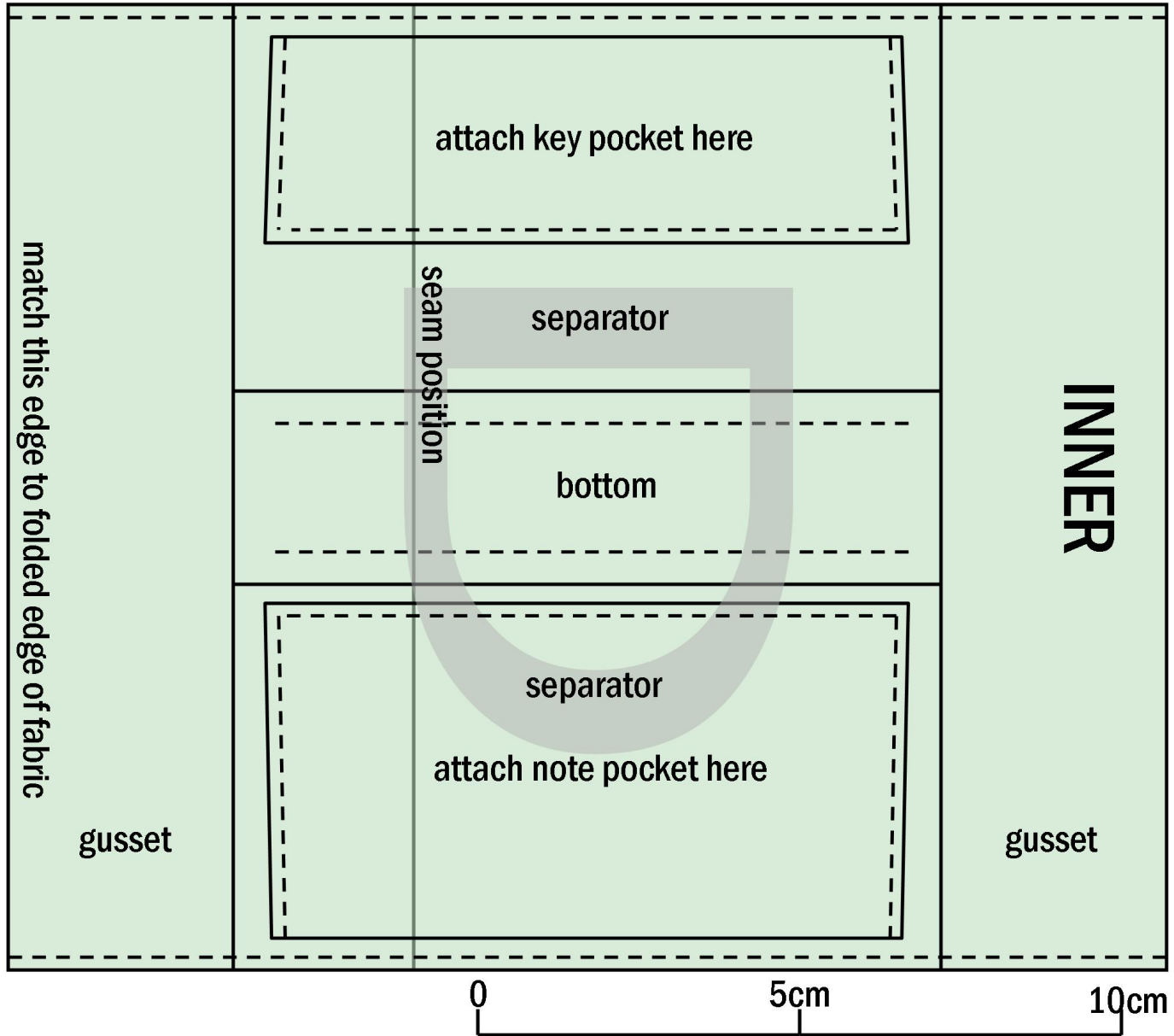

applying a ruler, check size of your print out

# 1 PRINT PATTERNS

print page 2 to 5 of this booklet on medium heavy paper (available for your printer) with actual size with settings shown in picture below.

applying your ruler at the scale on the print out, check your patterns is really 'actual size'.

cut print out along the bold out line to get five pattern pieces.

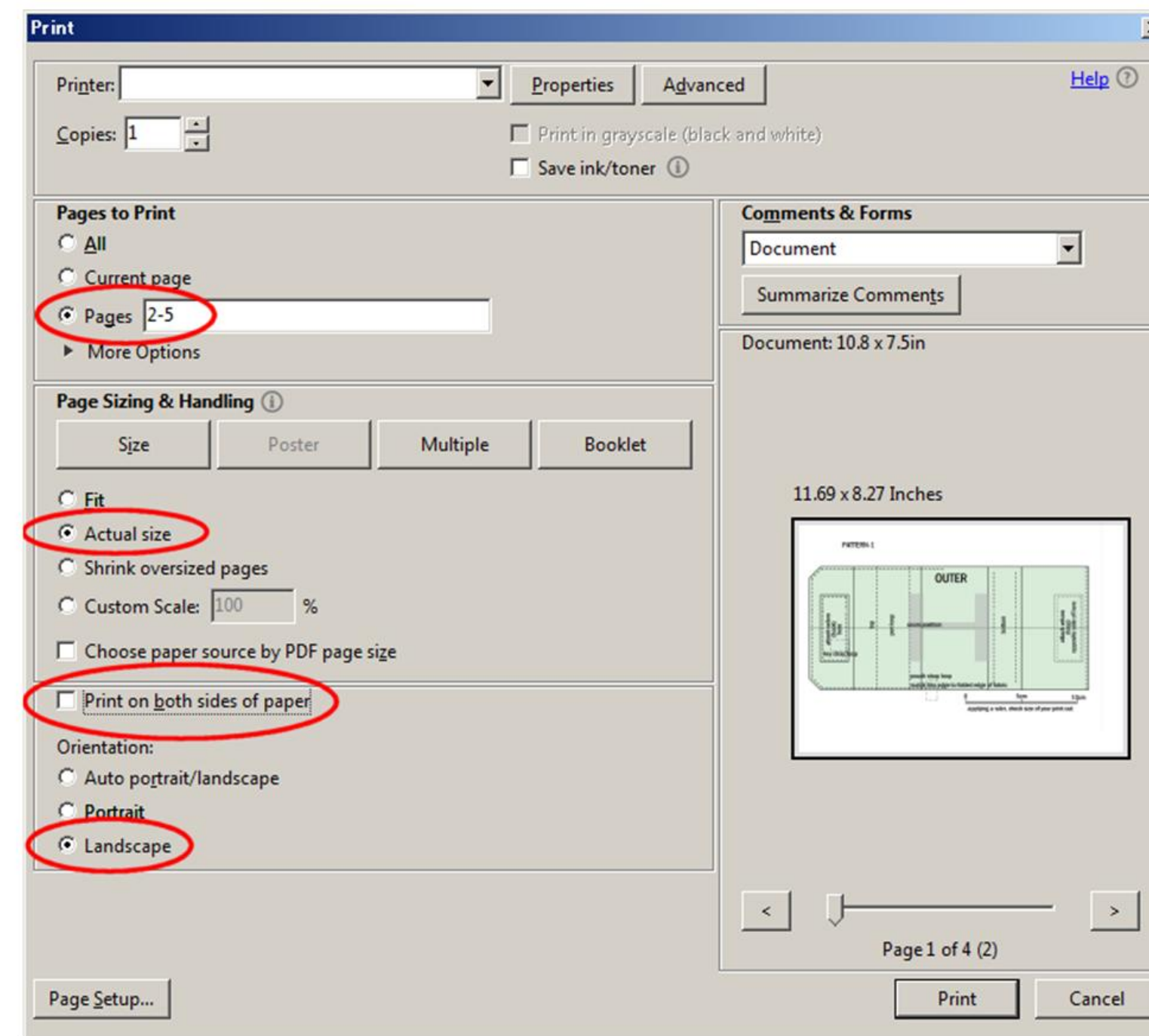

## 2 CUTTING

cut sheeting fabric (use your favorite color) along red lines, fold pieces at green lines in picture below.

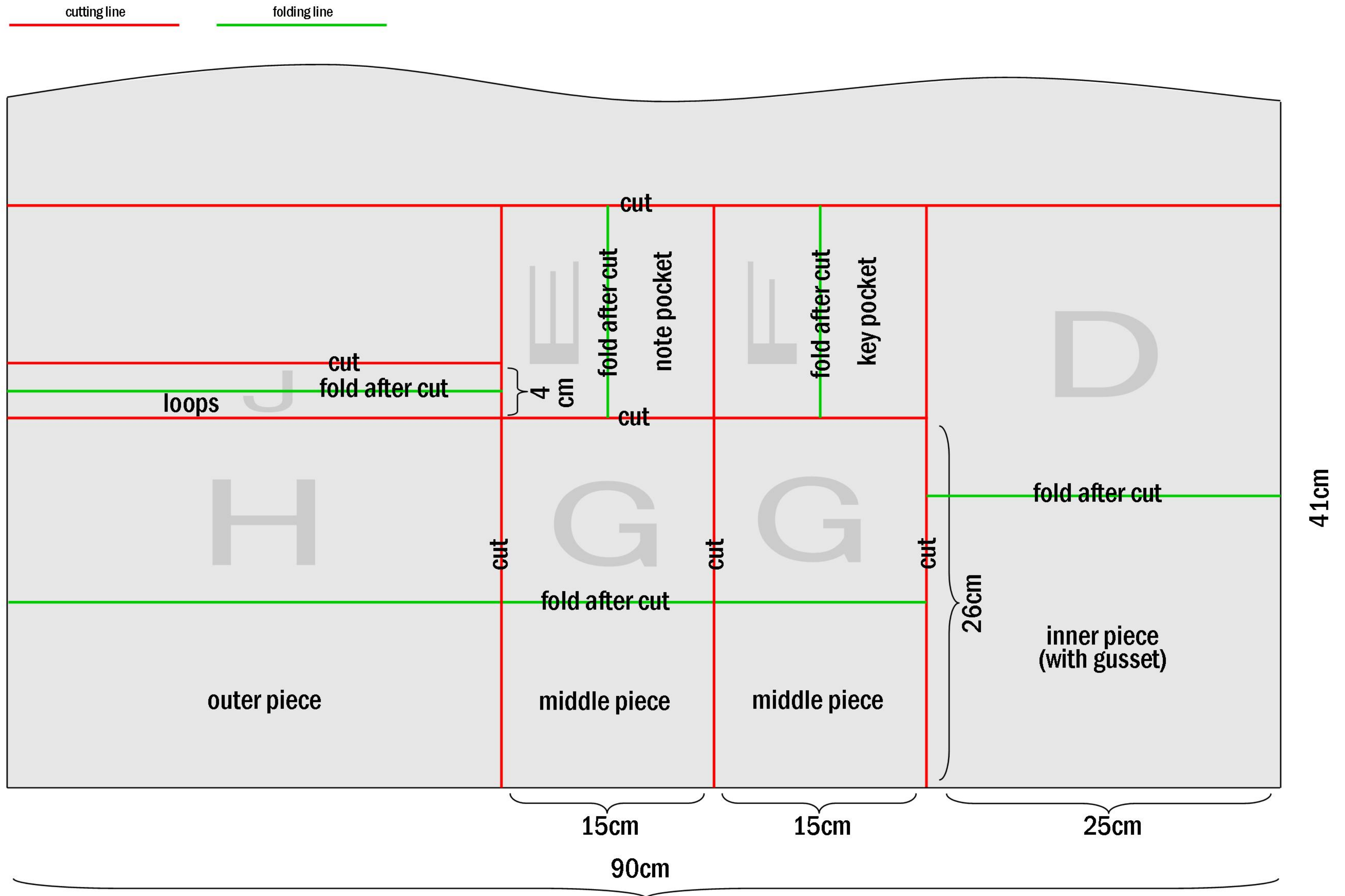

### 3 MAKING PIPES

applying patterns, mark and sew along the red dotted lines to produce pipes.  
then cut open edges adding 1cm seam allowance. (red lines)

coarse stitch (2.5mm)  
cutting line

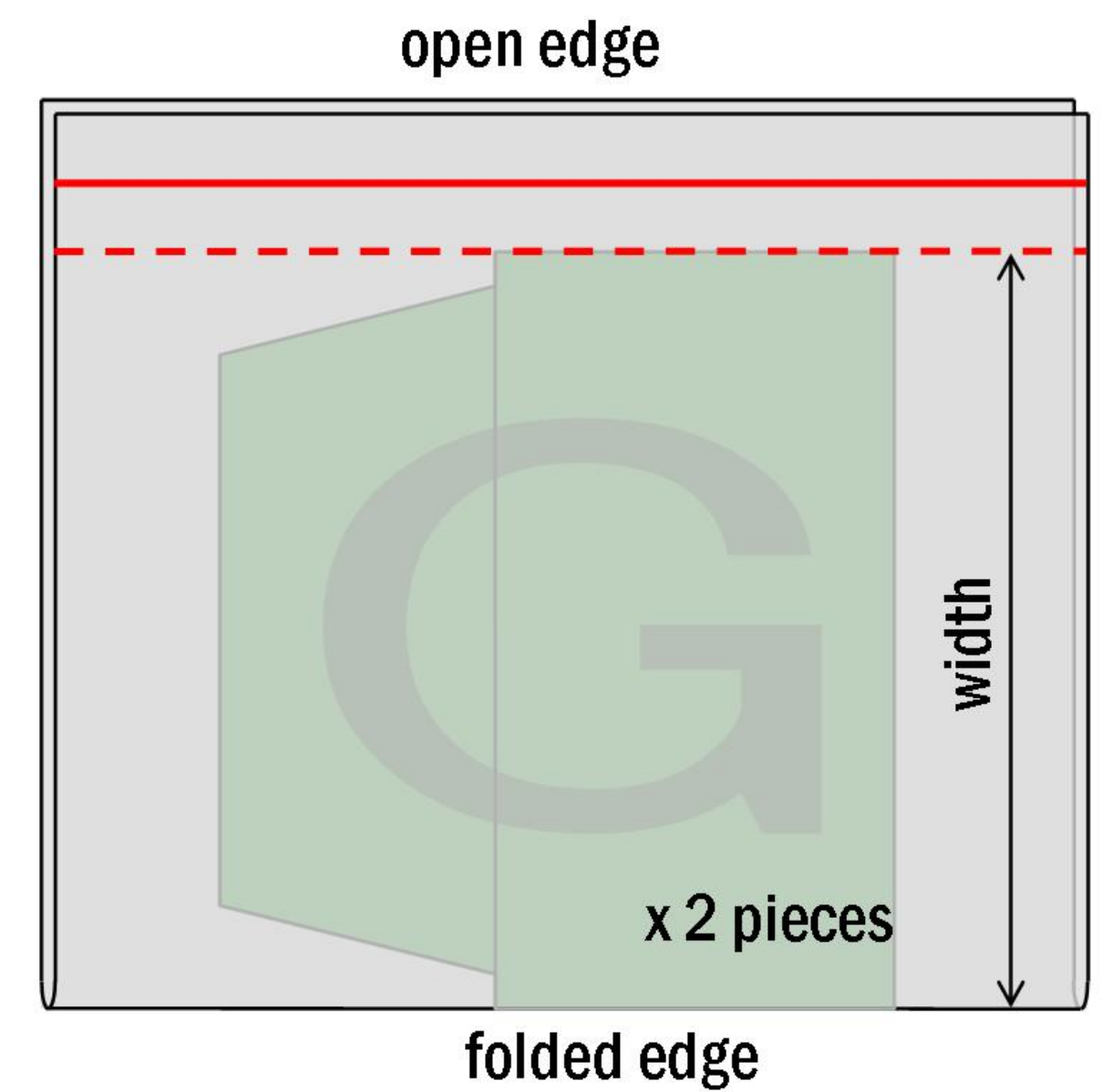
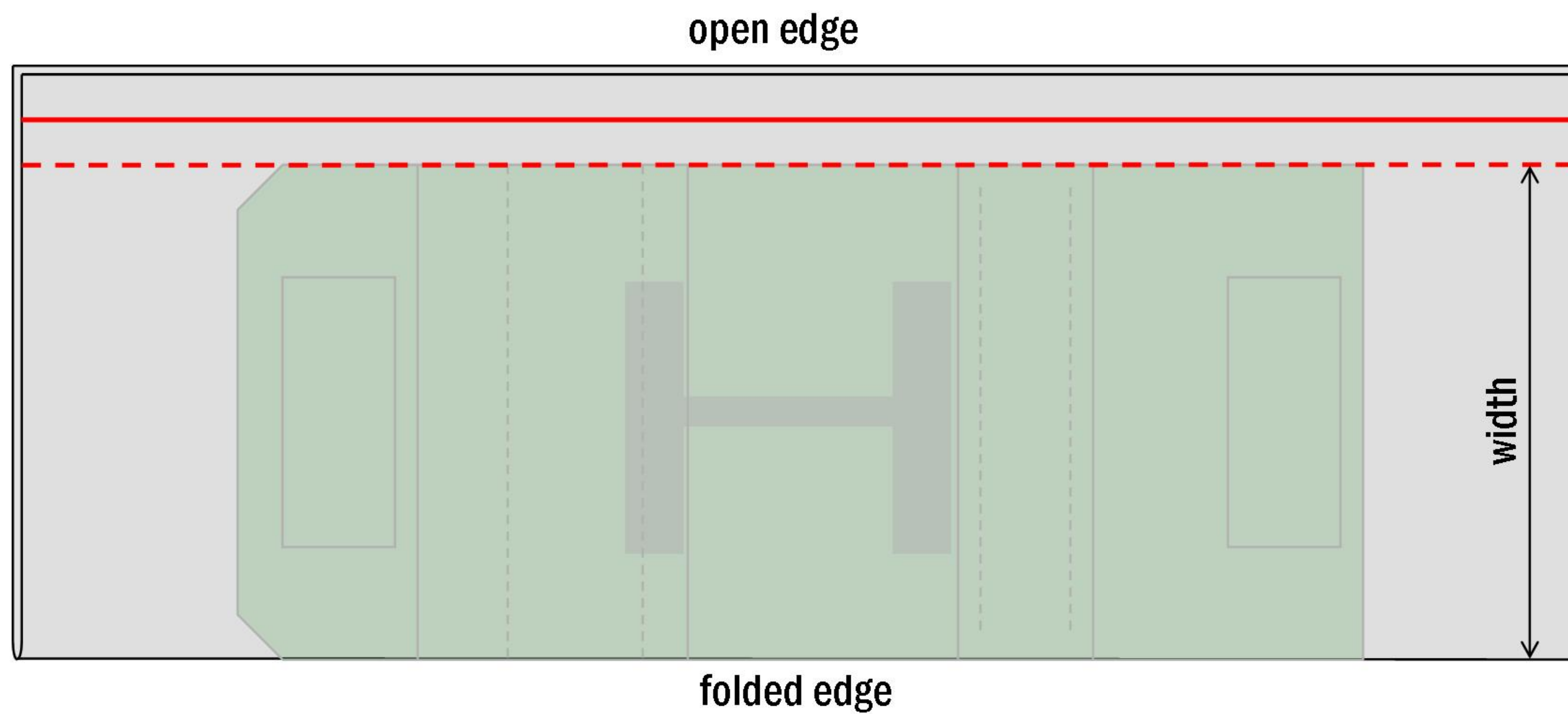
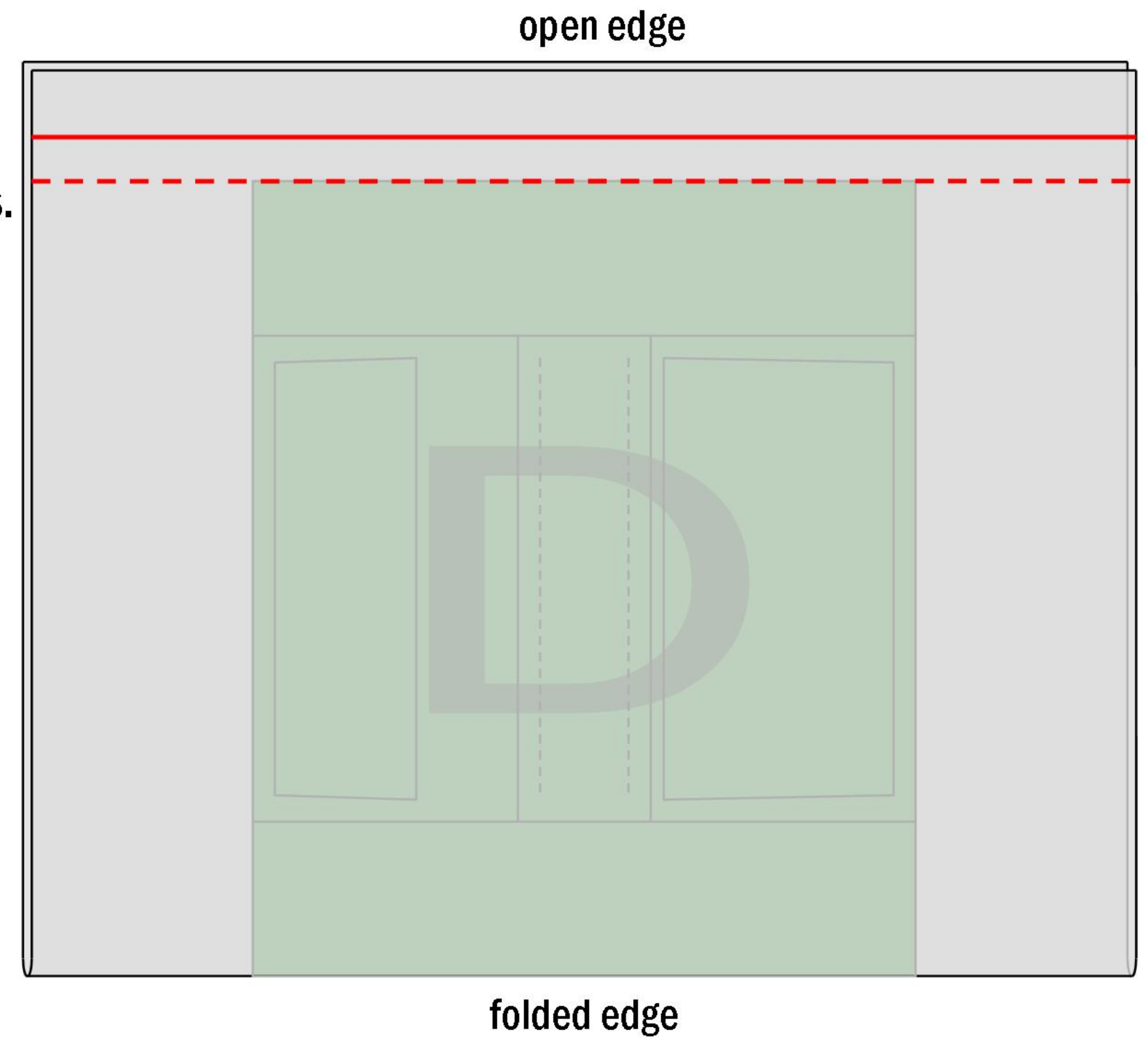
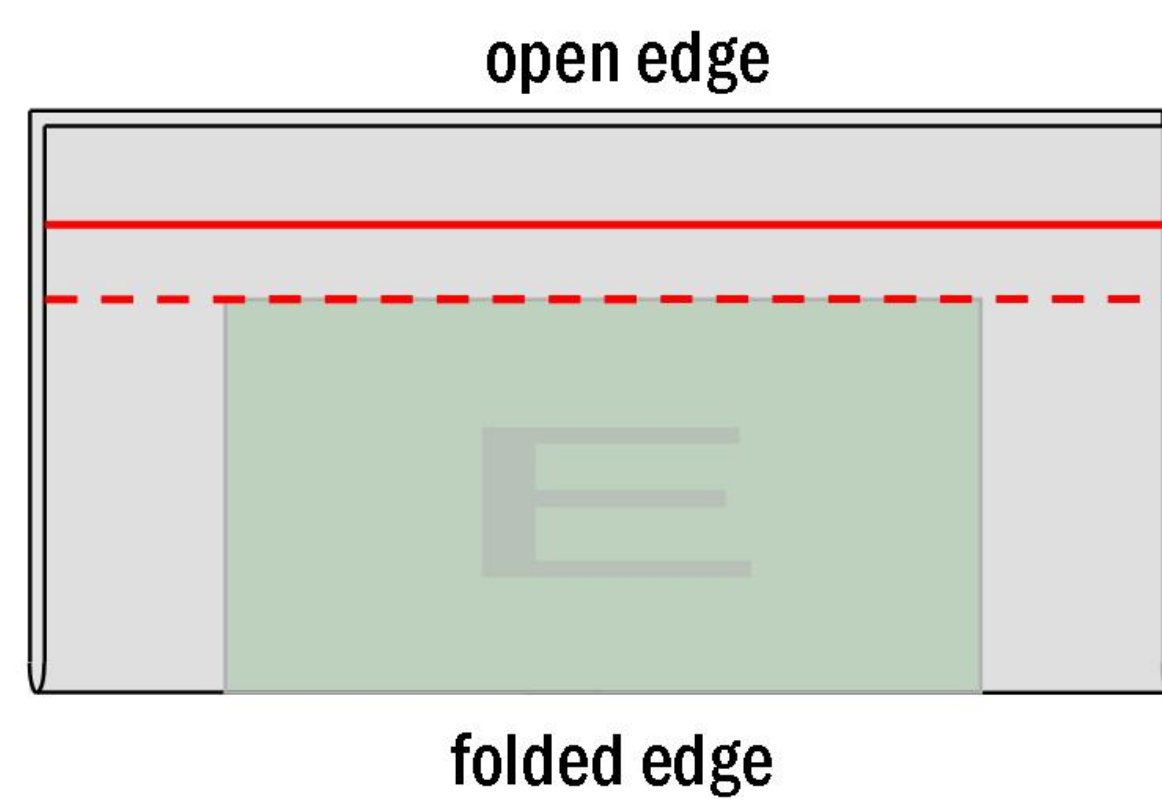
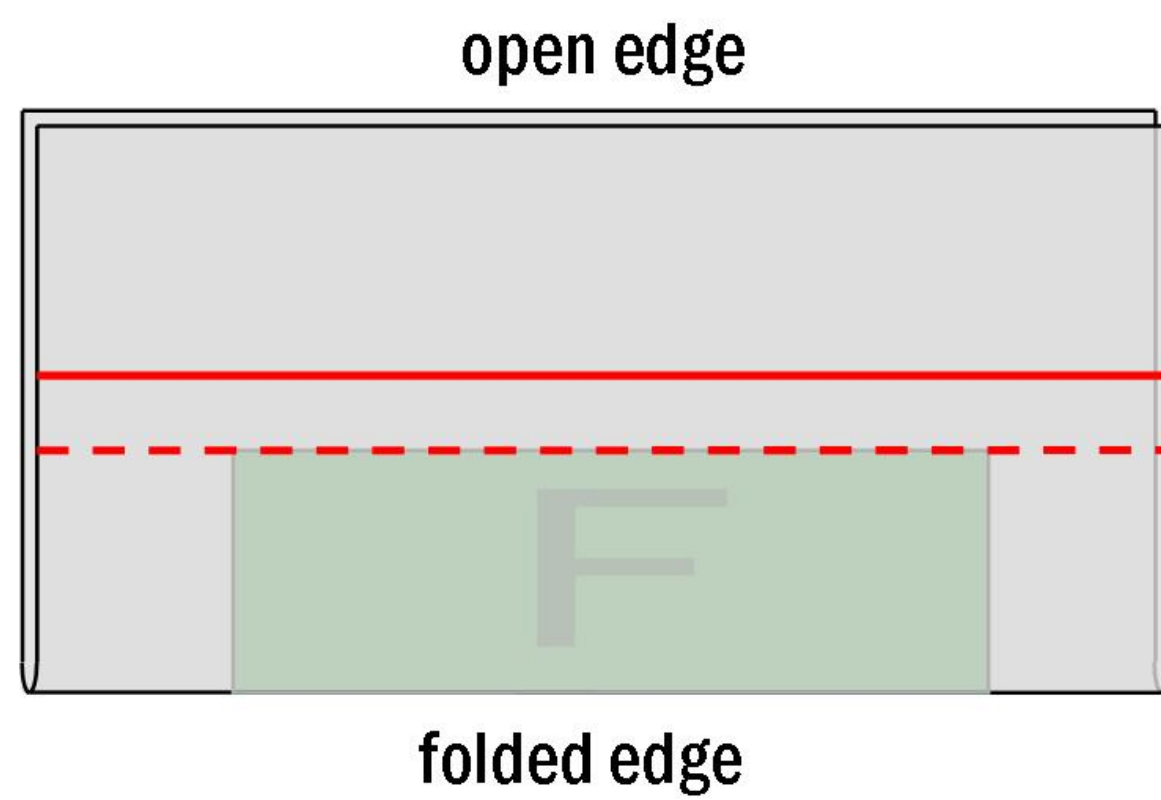



## 4 MOVING SEAMS

rotating the fabric, move the seam to the position shown on the pattern.

then spread open the seam.

do this work for all pieces except loops.

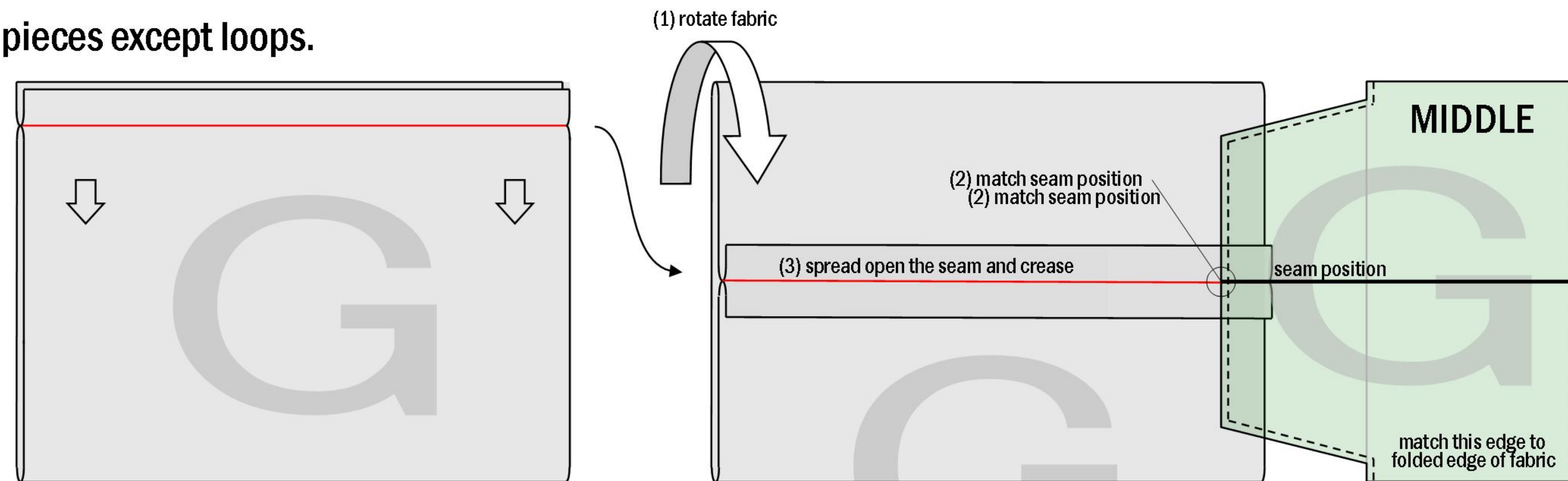

## 5 SEW LOOPS

folding and sewing a strip, create two loops for strap.

1 fold at center and crease enough. then unfold

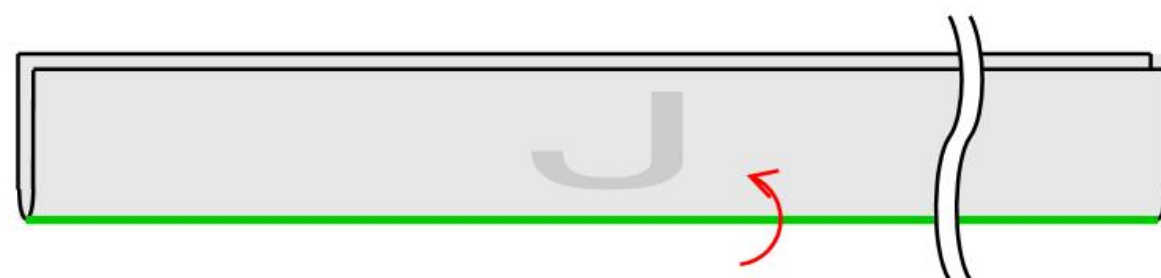

2 fold both edge

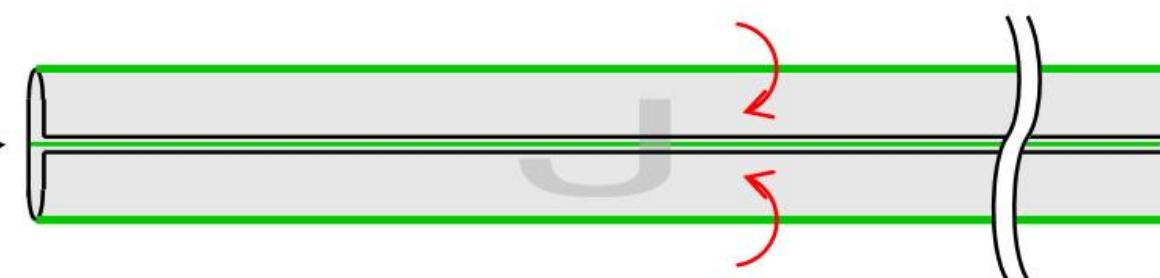

3 fold at center again and sew

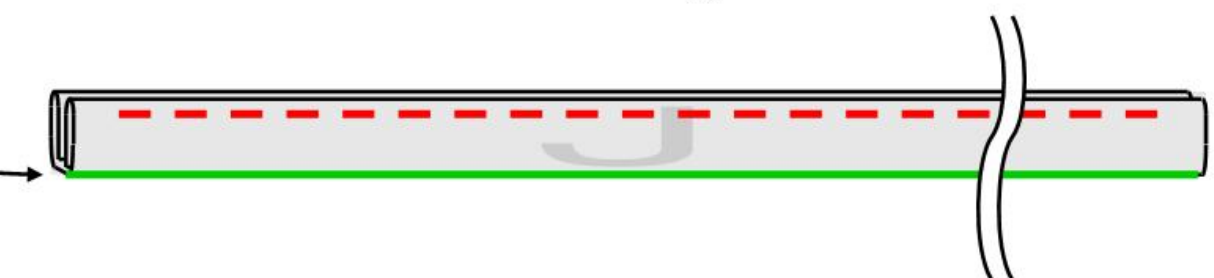

4 cut to trisect

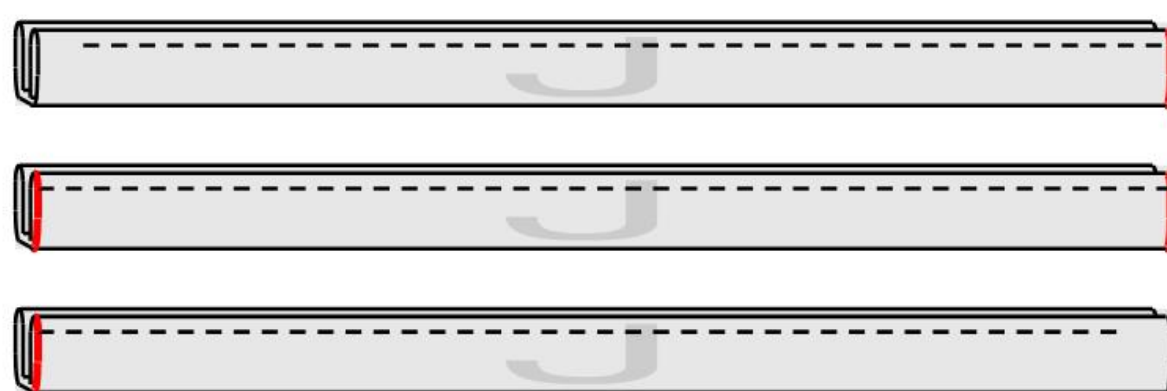

5 fold, sew and trim excess

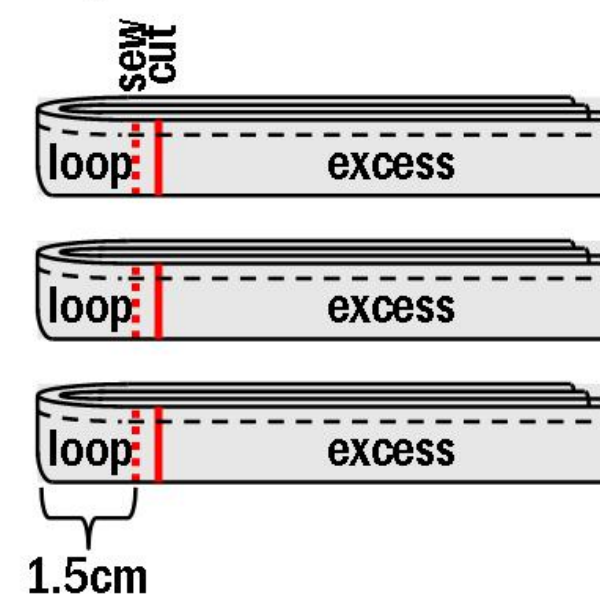

6 completed three loops



## 6 SEWING AND CUTTING

mark and sew along the red dotted lines shown in picture below.

applying patterns, mark green lines (will be folded next step).

then cut along the red lines. (1cm sewing allowance)

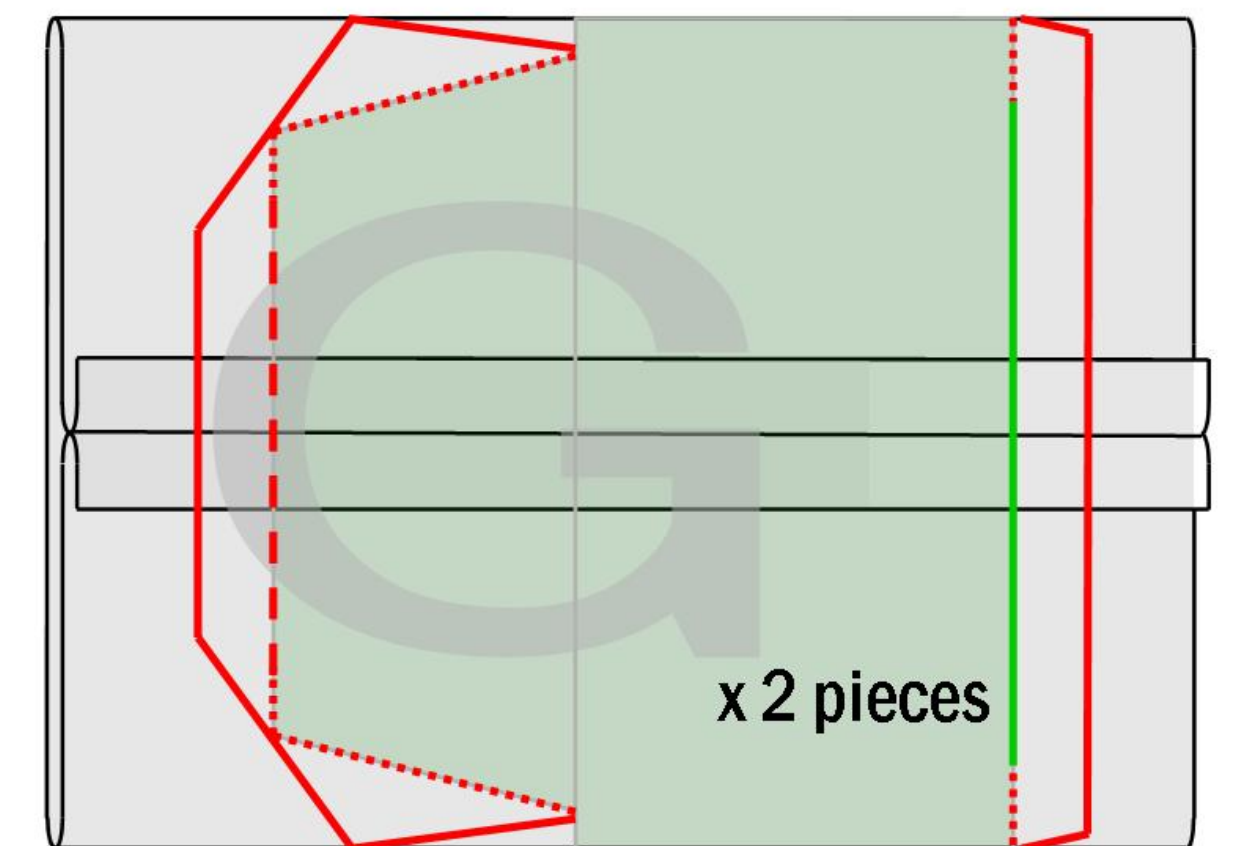
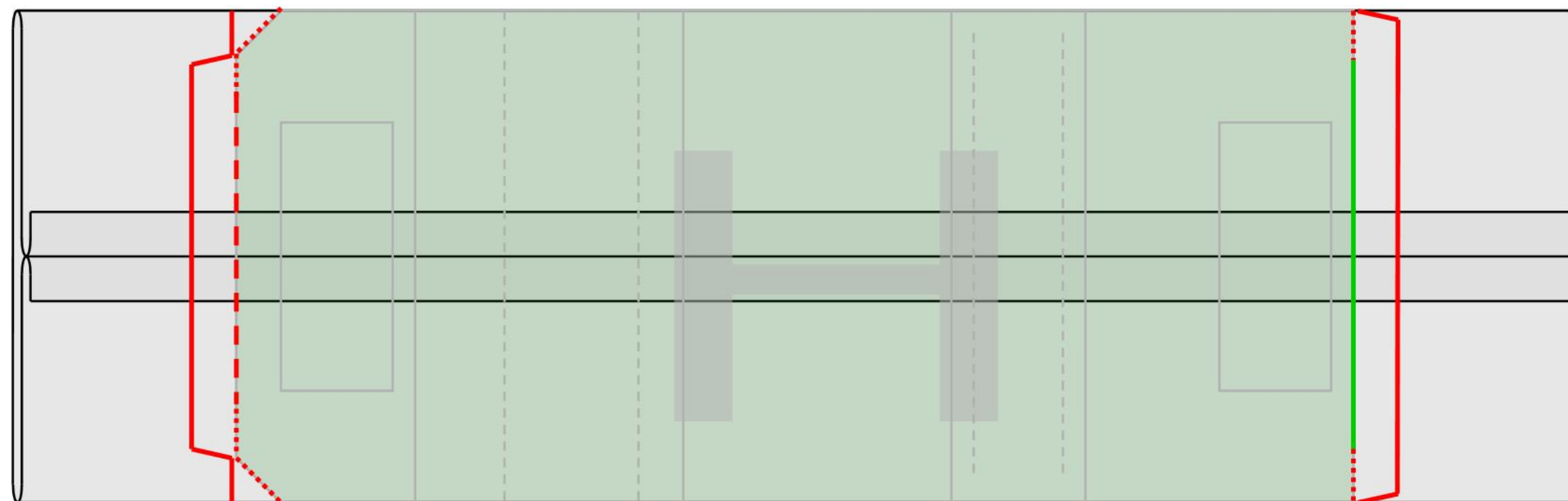
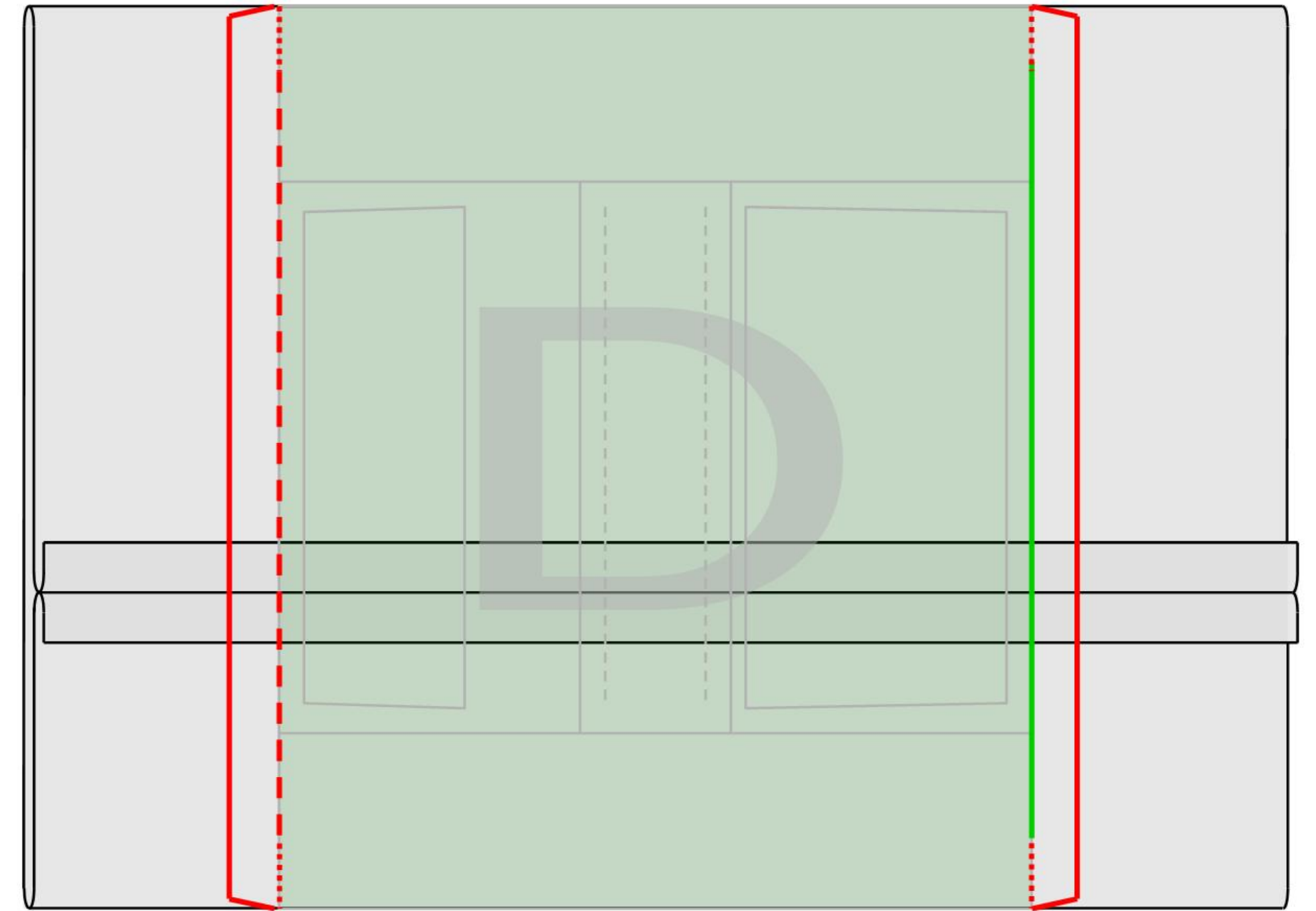
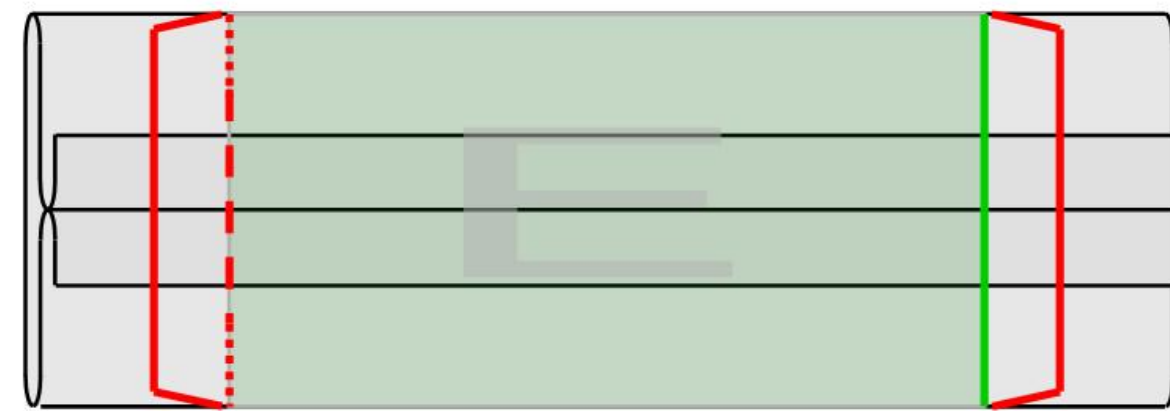
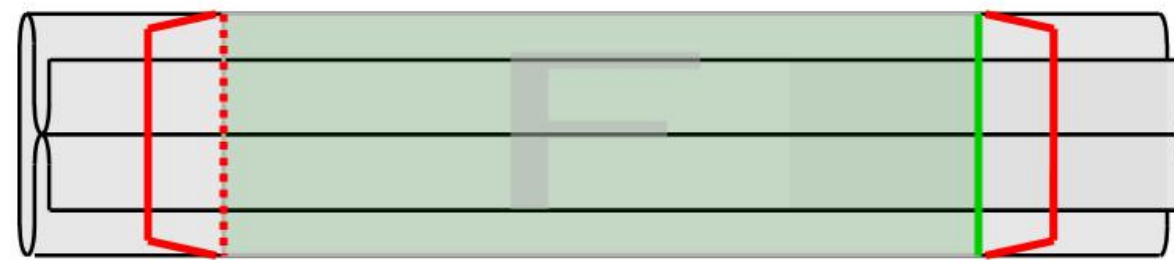
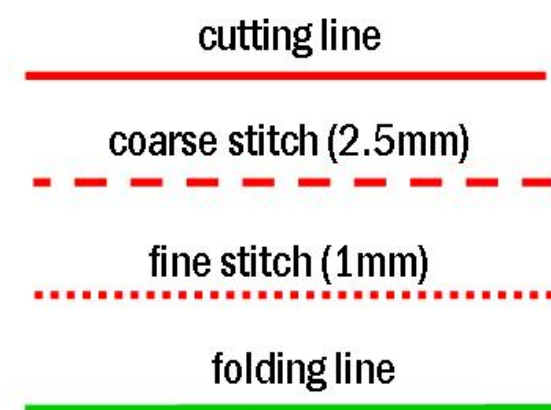

## 7 FOLDING BACK AND TURNING

applying patterns, fold back opening edge of piece and crease enough.

then turn inside out.

do this work for all six pieces except loop pieces.

in this instruction, we call the face which having a seam as 'back face', without a seam as 'front face'

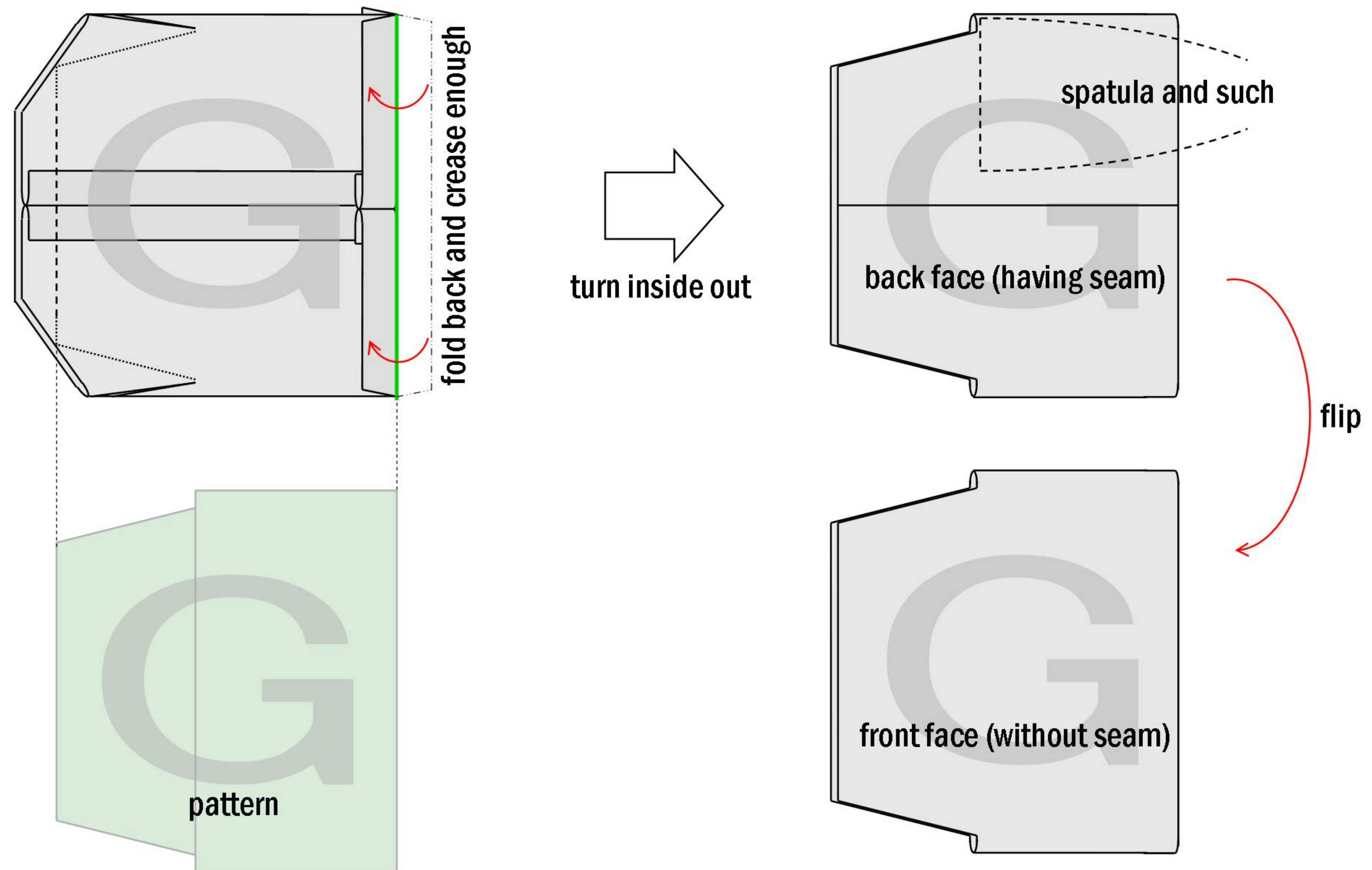

## 8 STITCHING

stitch fringe of the pieces along the red doted line.

coarse stitch (2.5mm)

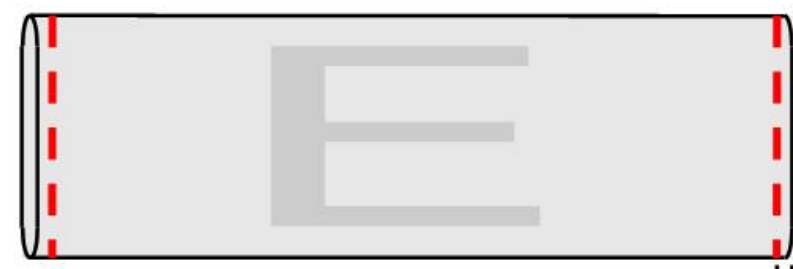

2 or 3mm

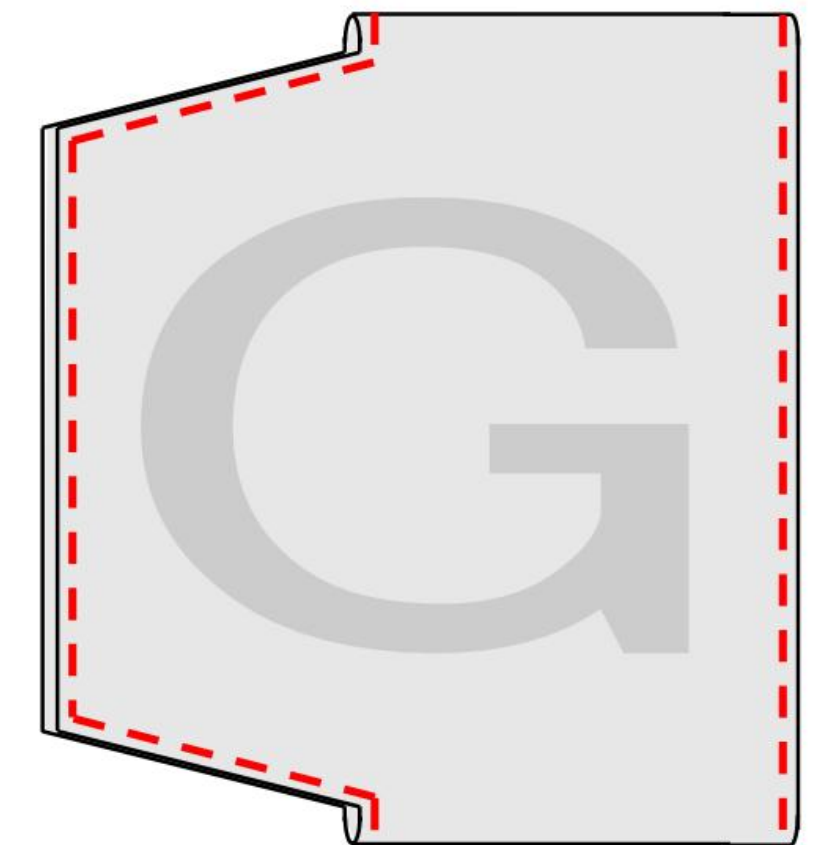
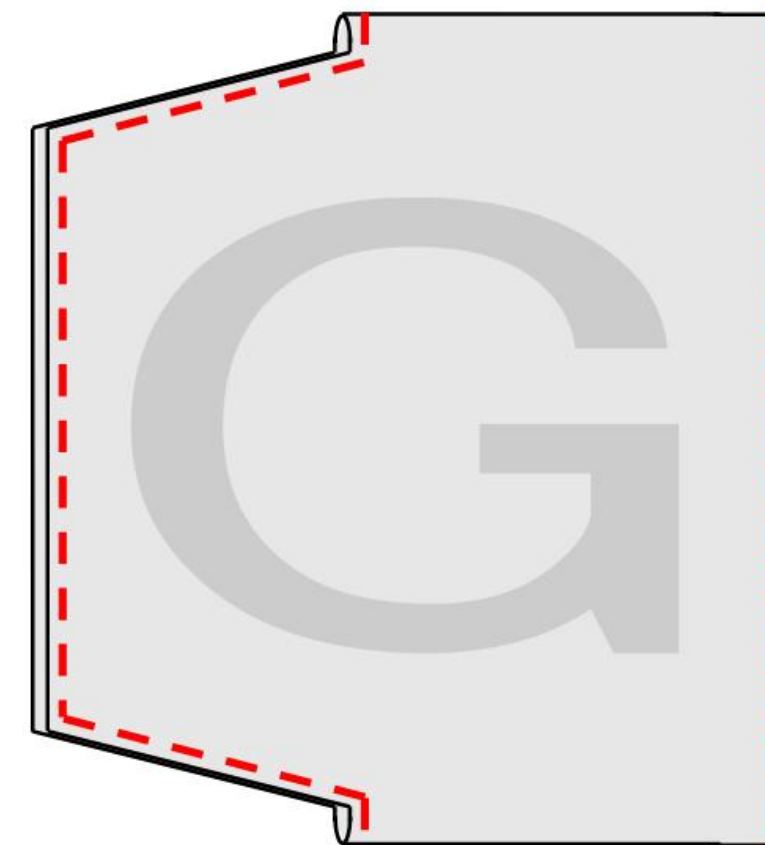
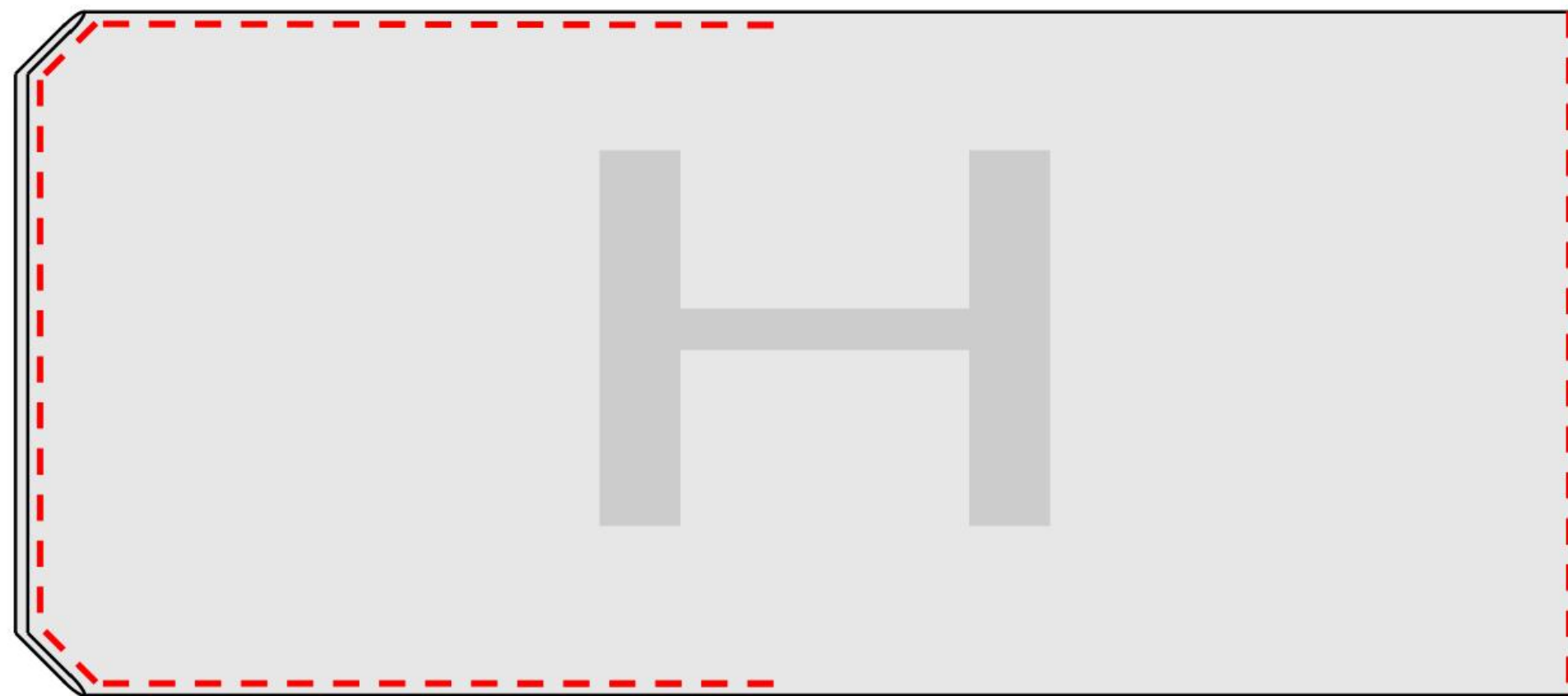
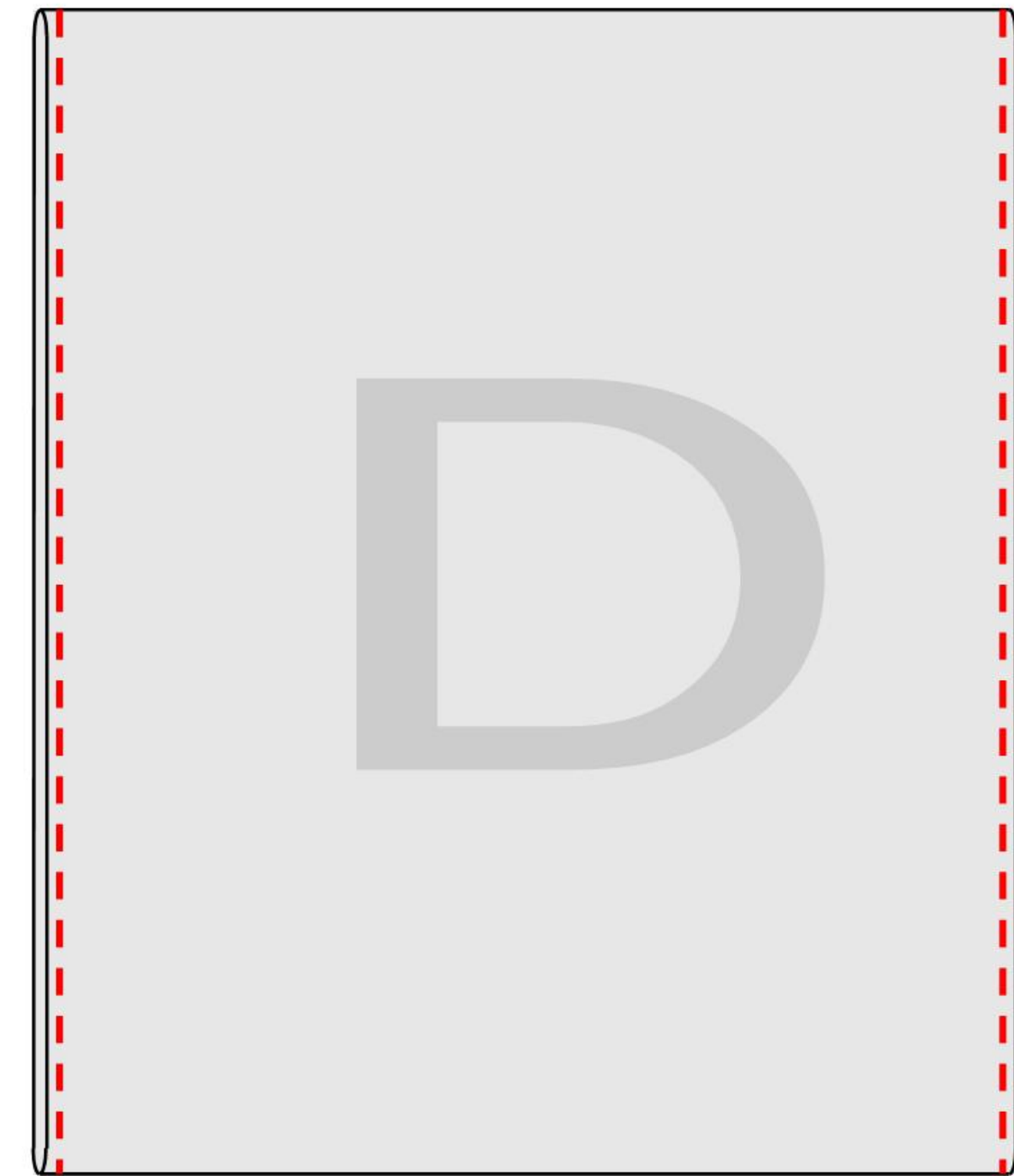

# 9 ASSEMBLING-1

in this page, you must be careful about seam position and face.

1. attach the velcro (hook side / hard) on the back face (having seam) of the outer piece, attach the velcro (loop side / soft) on the front face (without seam) of the outer piece.
2. to create a pen loop, fold outer piece (back face out) and sew.

## 1 ATTACHING VELCROS

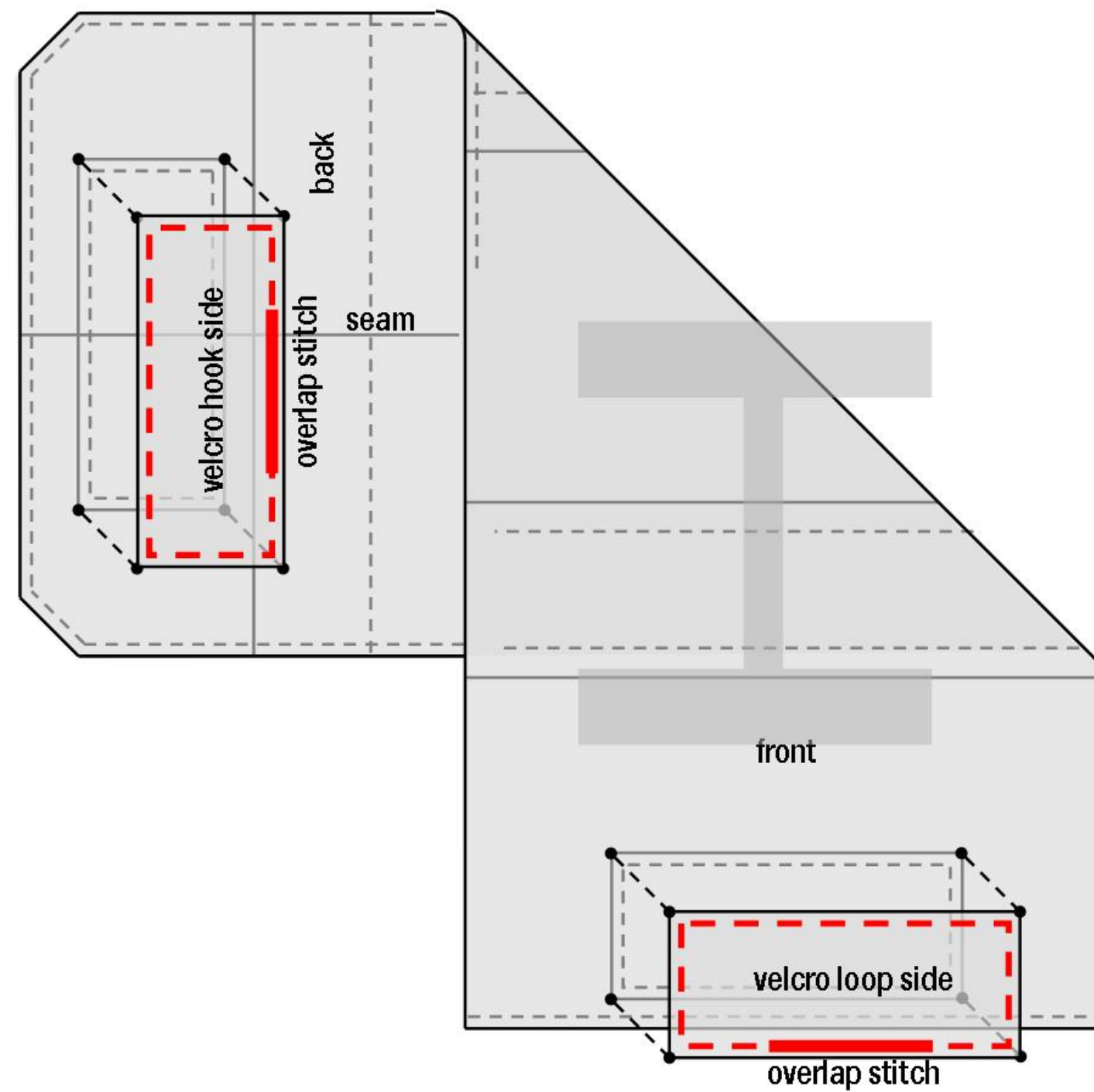

## 2 MAKING PEN LOOP

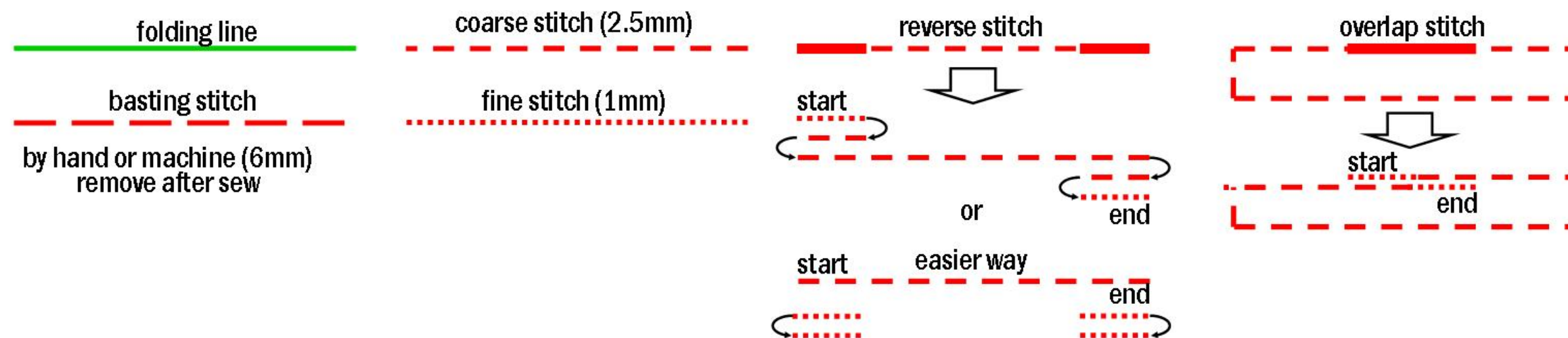
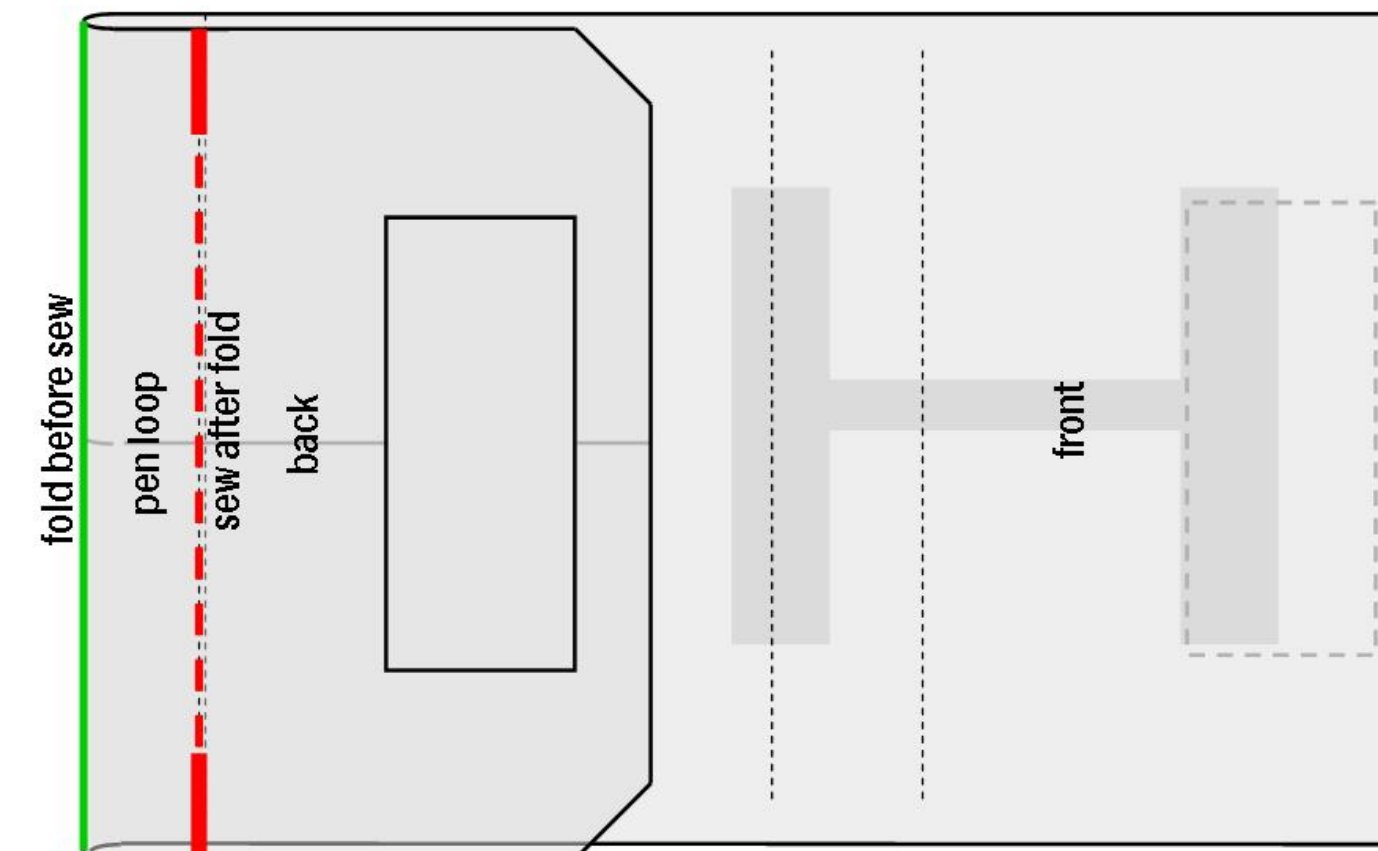

# 10 ASSEMBLING-2

in this page, you must be careful about seam position and face.

1. temporarily attach the strap loops on the back face of the outer piece.
3. slacking opening side of the pockets about 1mm at each side, attach the pocket pieces on the front face of the inner piece. then fold both side of the inner piece, to adjust the width correctly same with outer piece.

## 1 ATTACHING STRAP LOOP

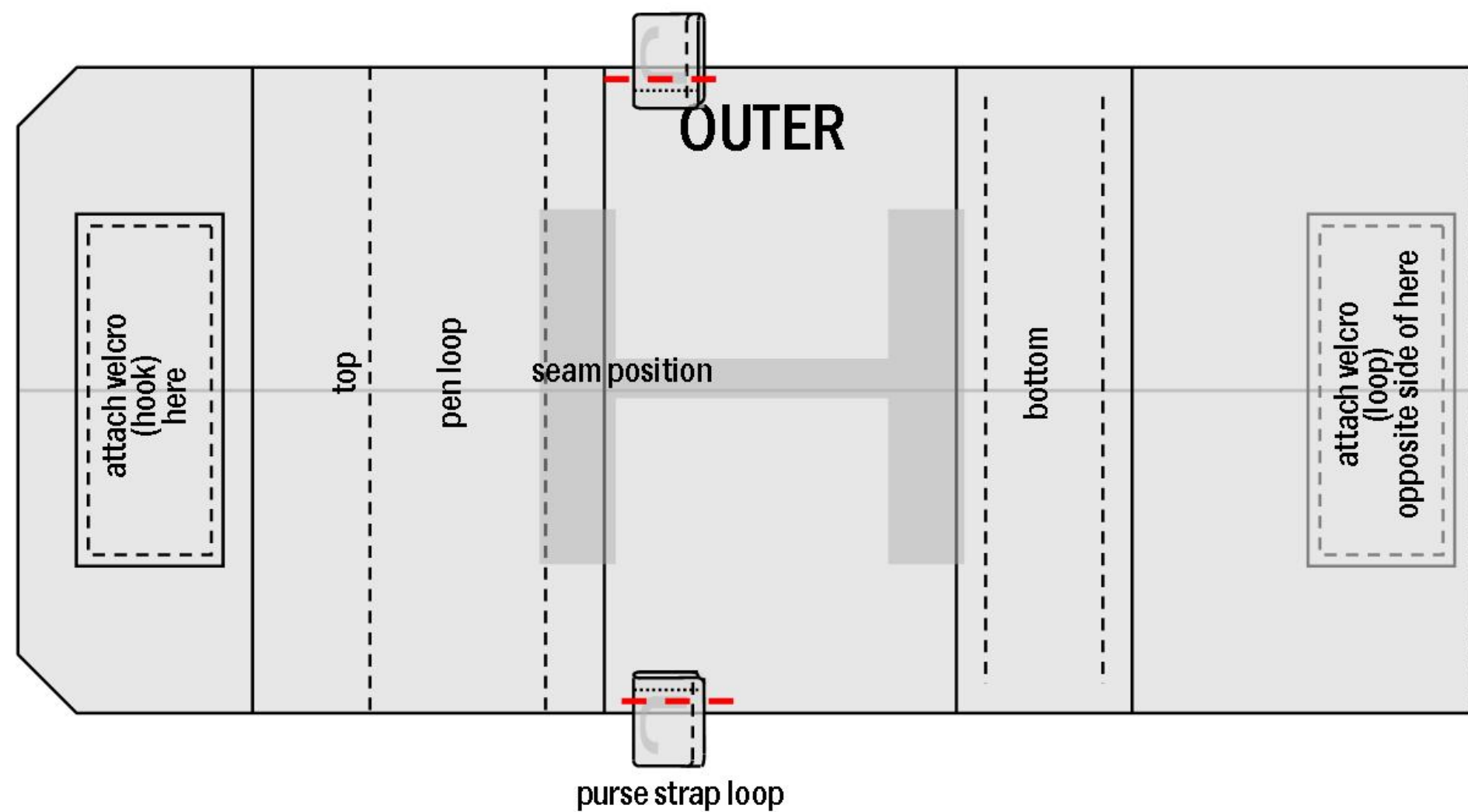

## 2 ATTACHING POCKETS AND KEY LOOP

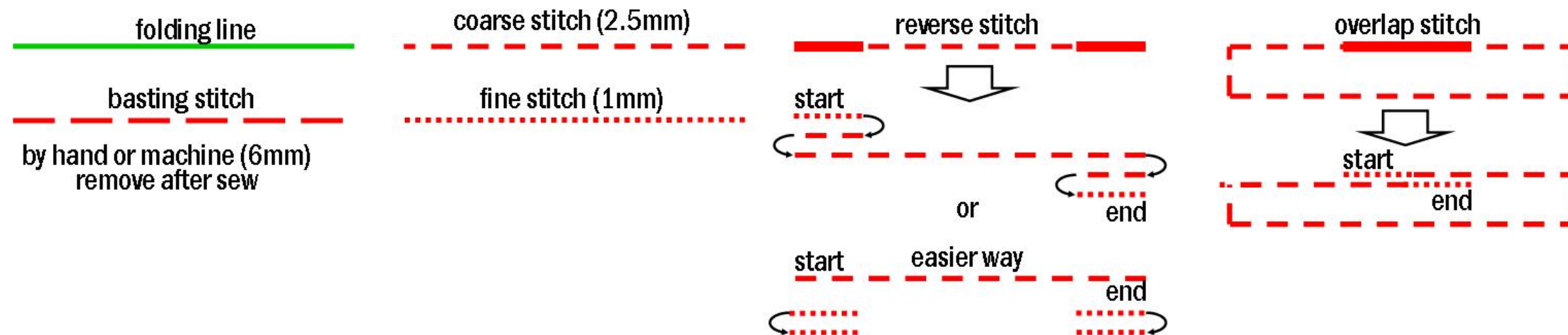
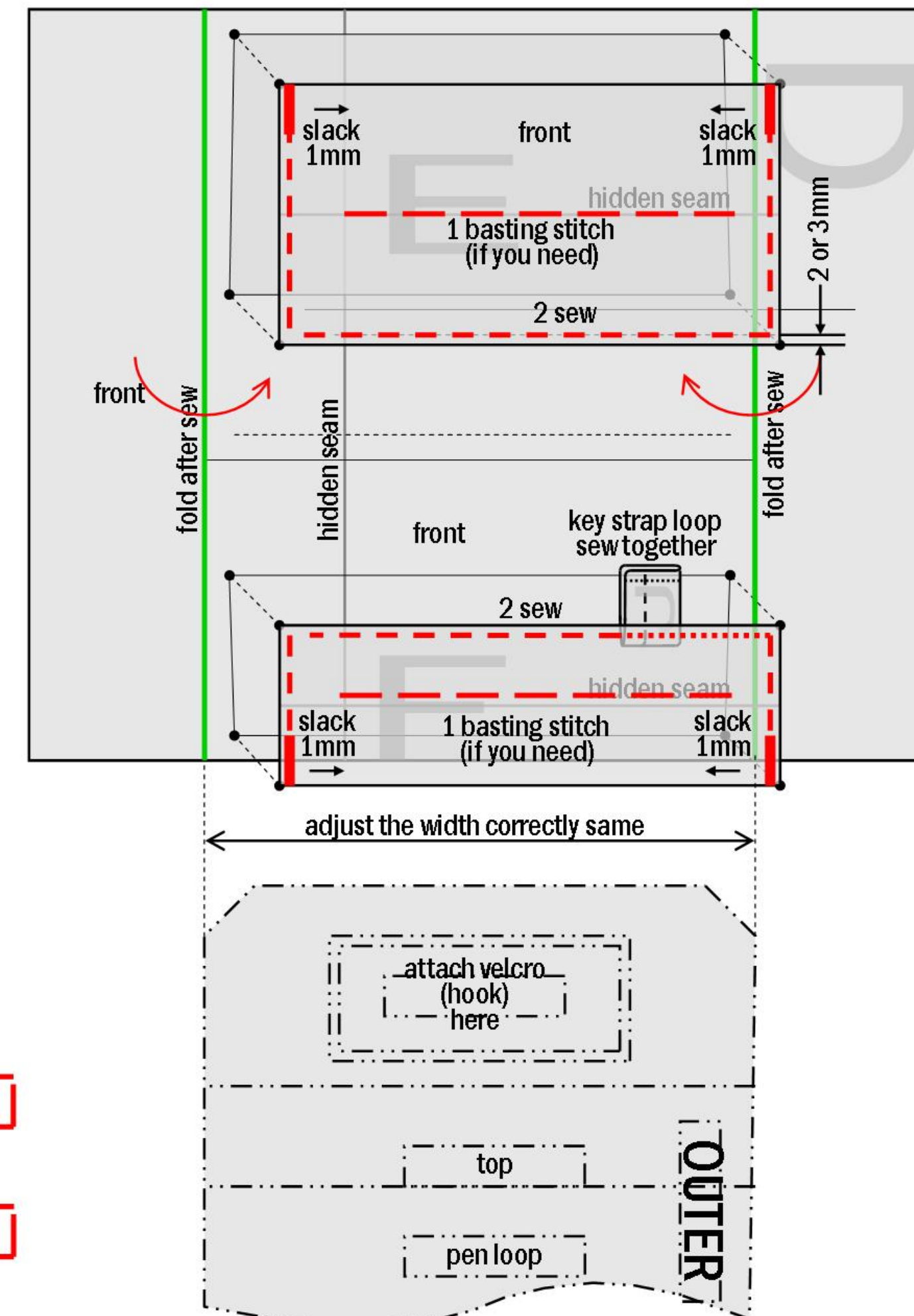

# 11 ASSEMBLING-3 (COMPLETE)

in this page, you must be careful about seam position and face.

1. layer the outer, middle, inner pieces. then basting stitch and sew together along red dotted line.
2. spread the gussets and sew inner and outer together at the bottom portion.
3. fold whole work at the bottom (outer piece inside). basting stitch and sew both gusset edges.

## 3 SEWING GUSSET

### 1 SEWING SIDE

### 2 SEWING BOTTOM

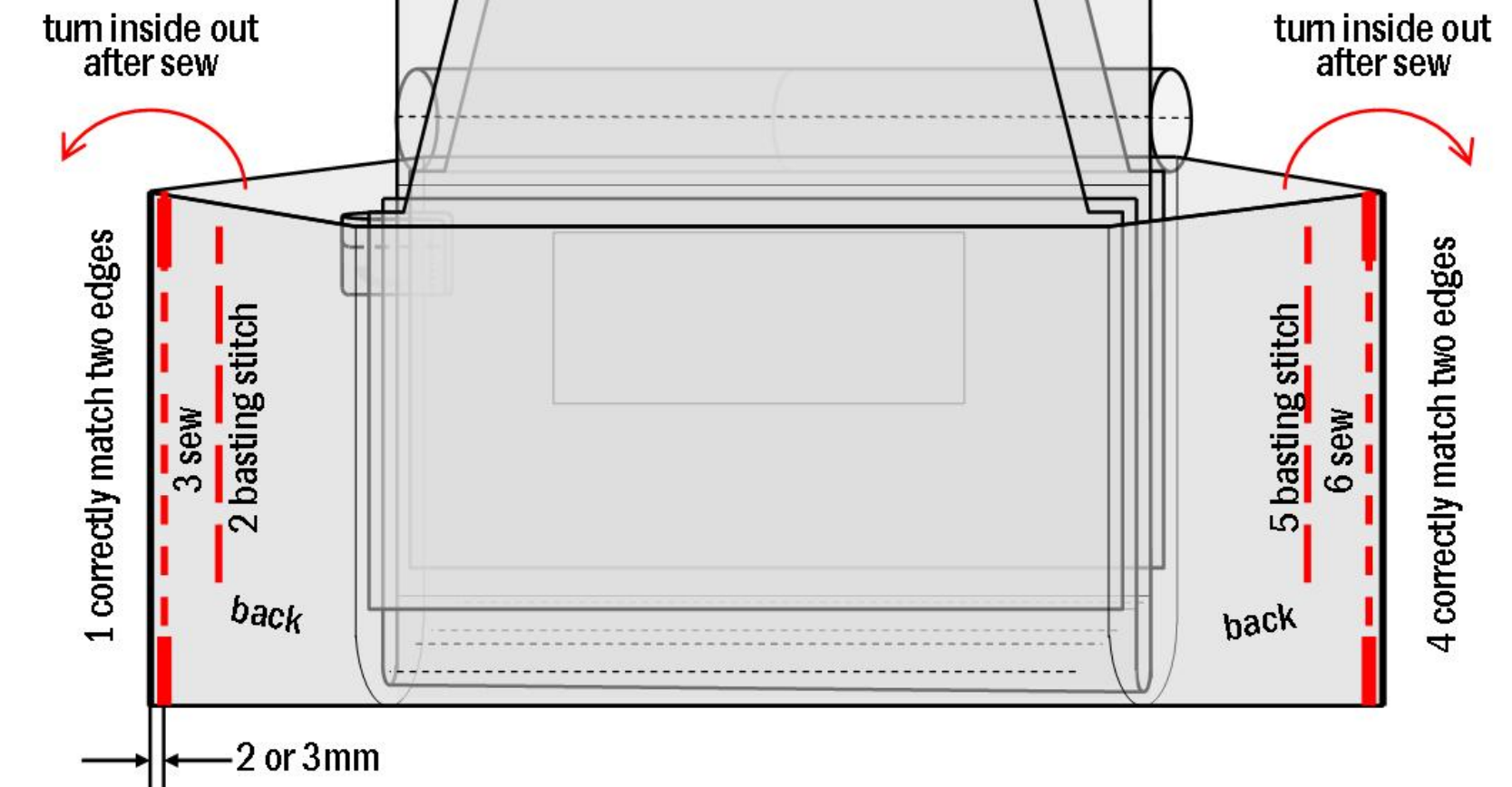

### 4 COMPLETE

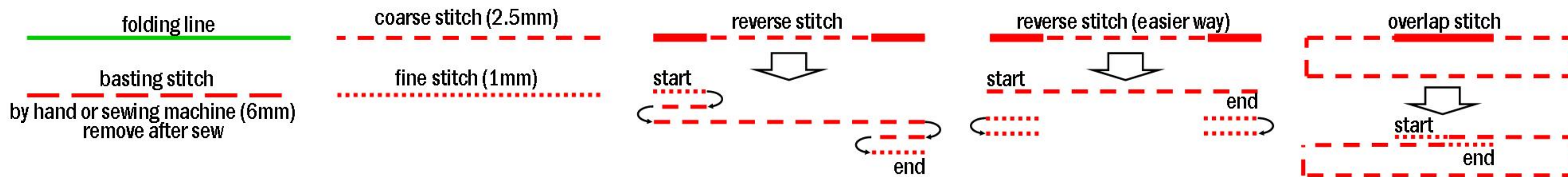
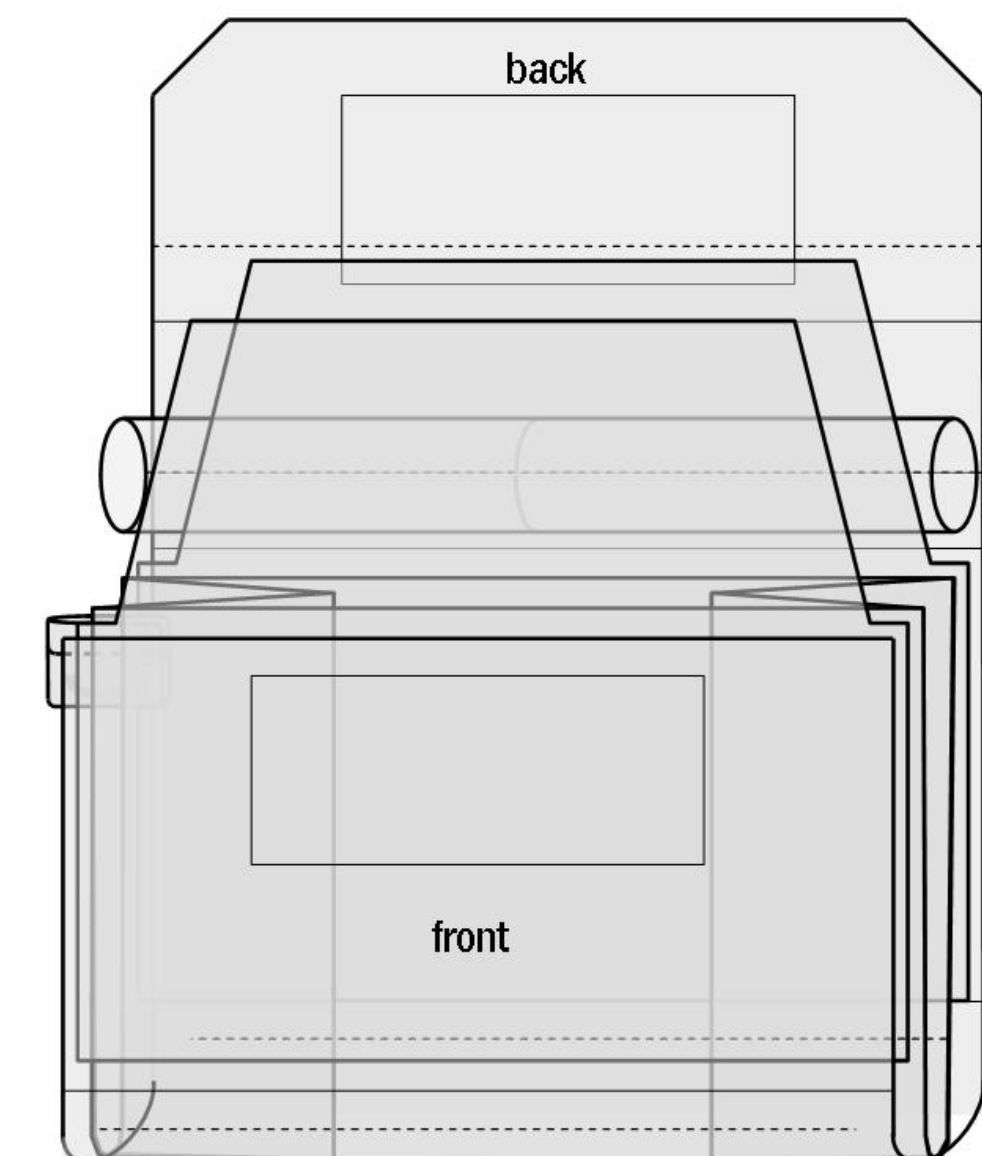
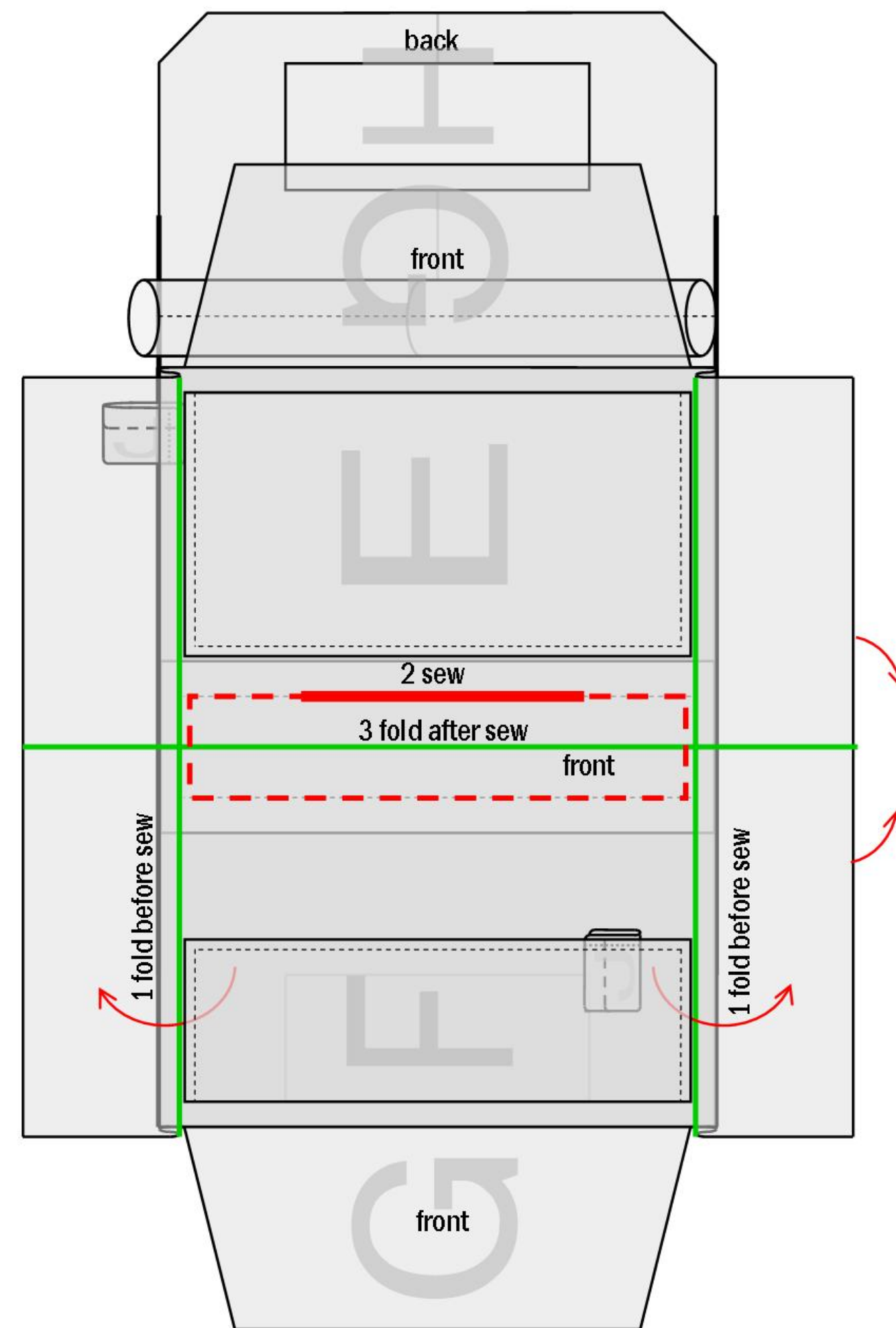
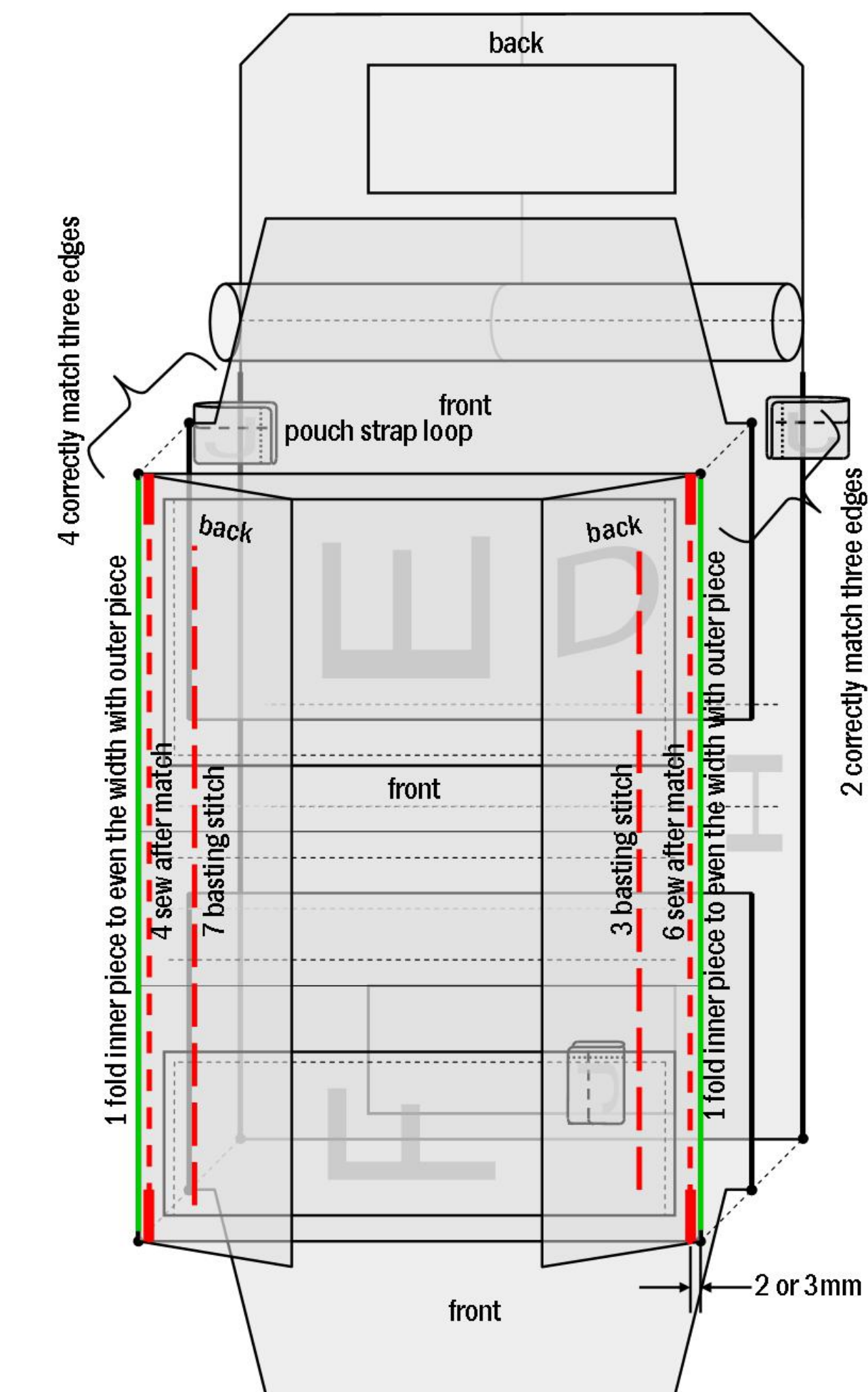

# 12 STRAP FOR KEY AND PURSE

twisted braided elastic rings are very useful for key strap and purse strap. because it is expandable and exchangeable.

1 make a knot and through the end into the eye

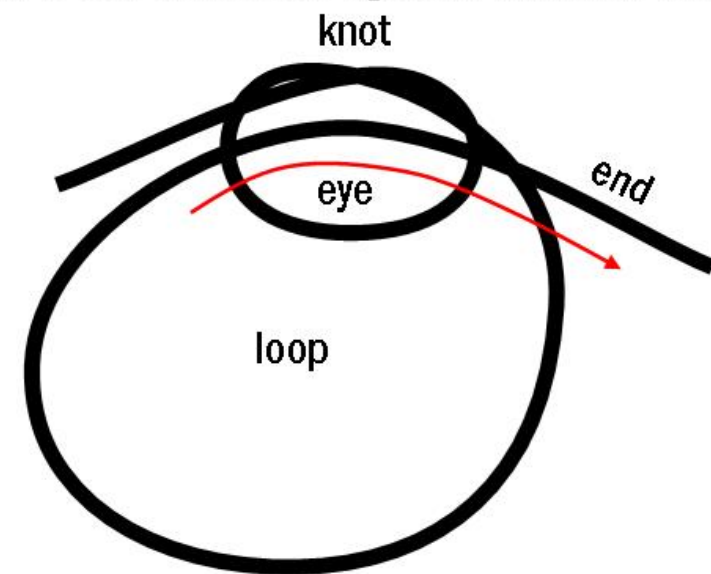

2 twist the end. loop is spontaneously twisted

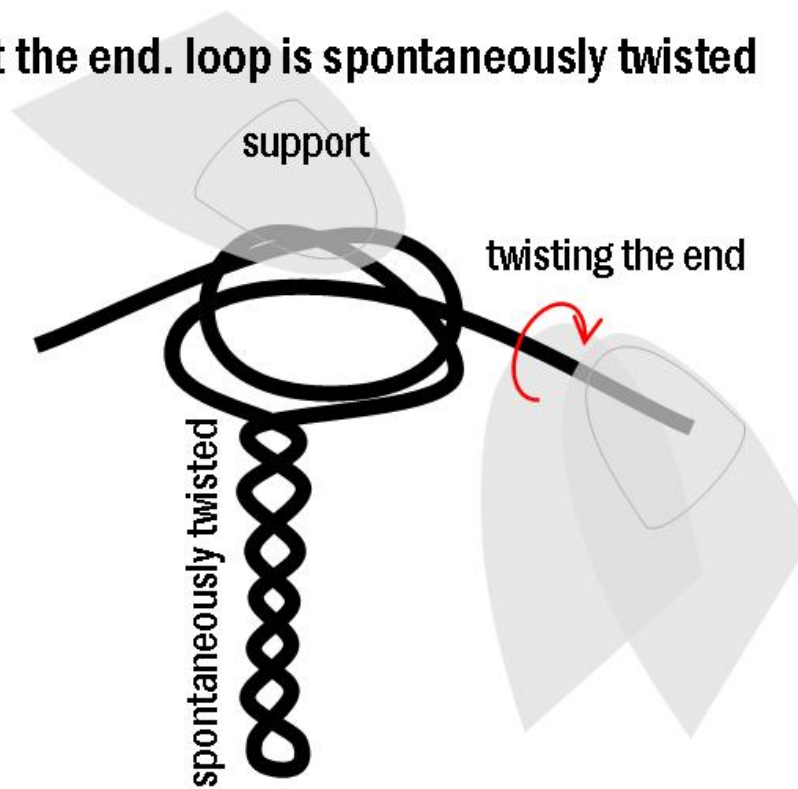

3 secure the knot not to be rewound the twist

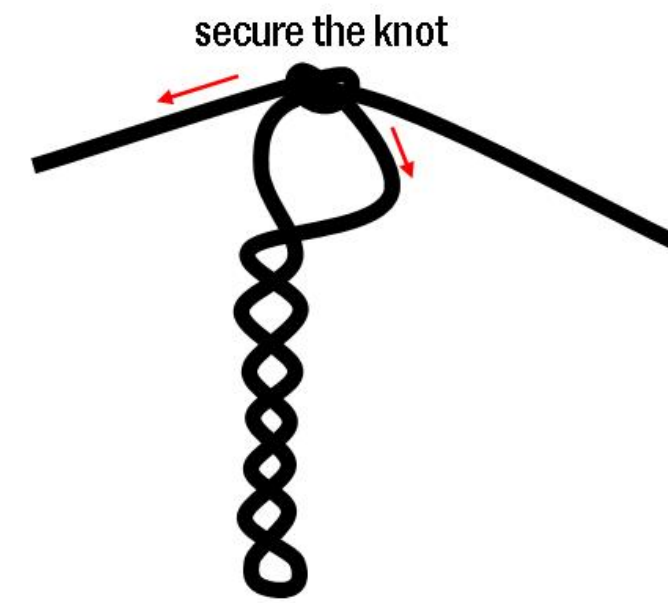

4 make more one knot

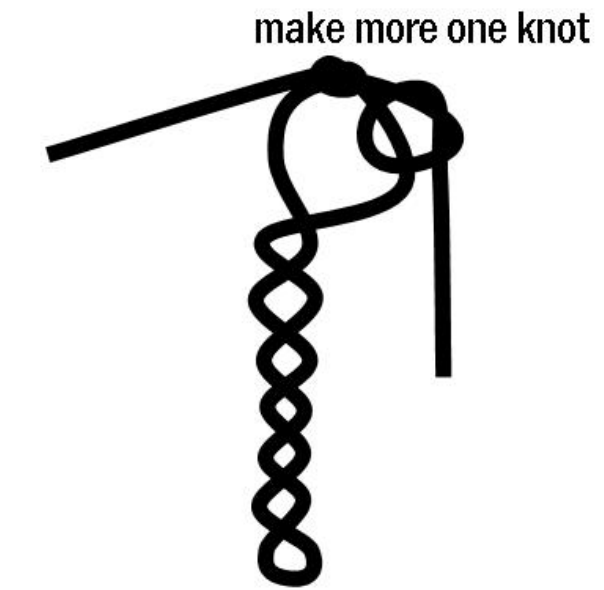

5 secure the knot

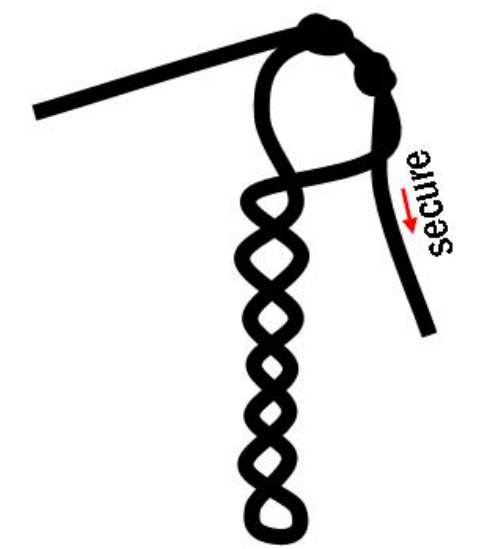

6 secure the ring and trim excess

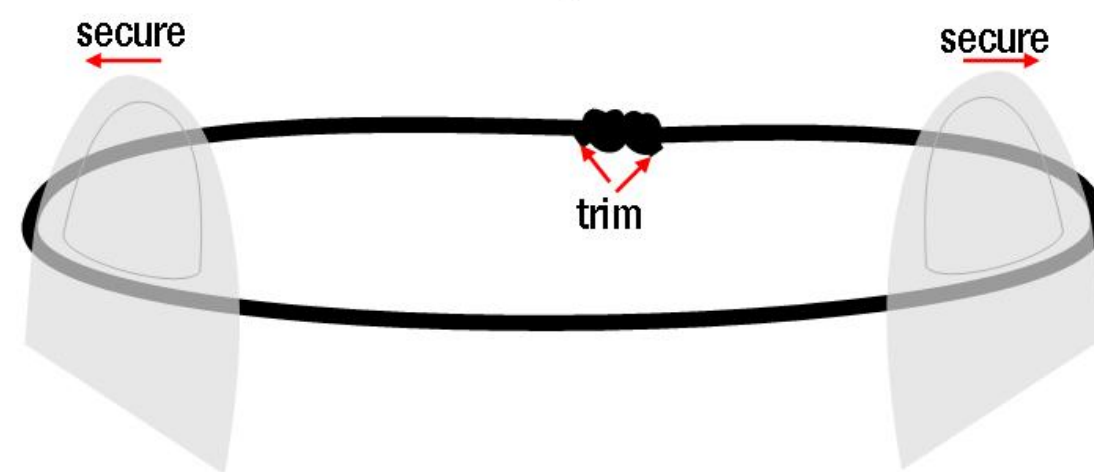

7 complete

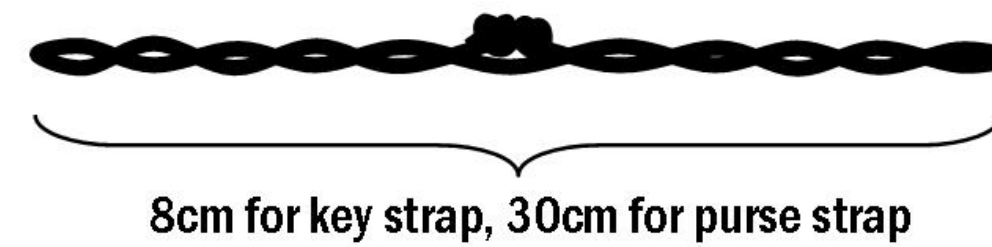

**how to use**  
you can attach and detach a key without knotting.

